

Lengde- og tverrprofiler mm.

Detaljregulering Arna. Gnr. 284, Bnr. 64. m.fl., Øvre Seimsmark - Bjørarhallen
ArealplanID 70560000

Tegninger utarbeidet av:



*Lengde- og tverrprofiler
Snitt Øvre Seimsmark
Skiltplan ny trafikkløsning*

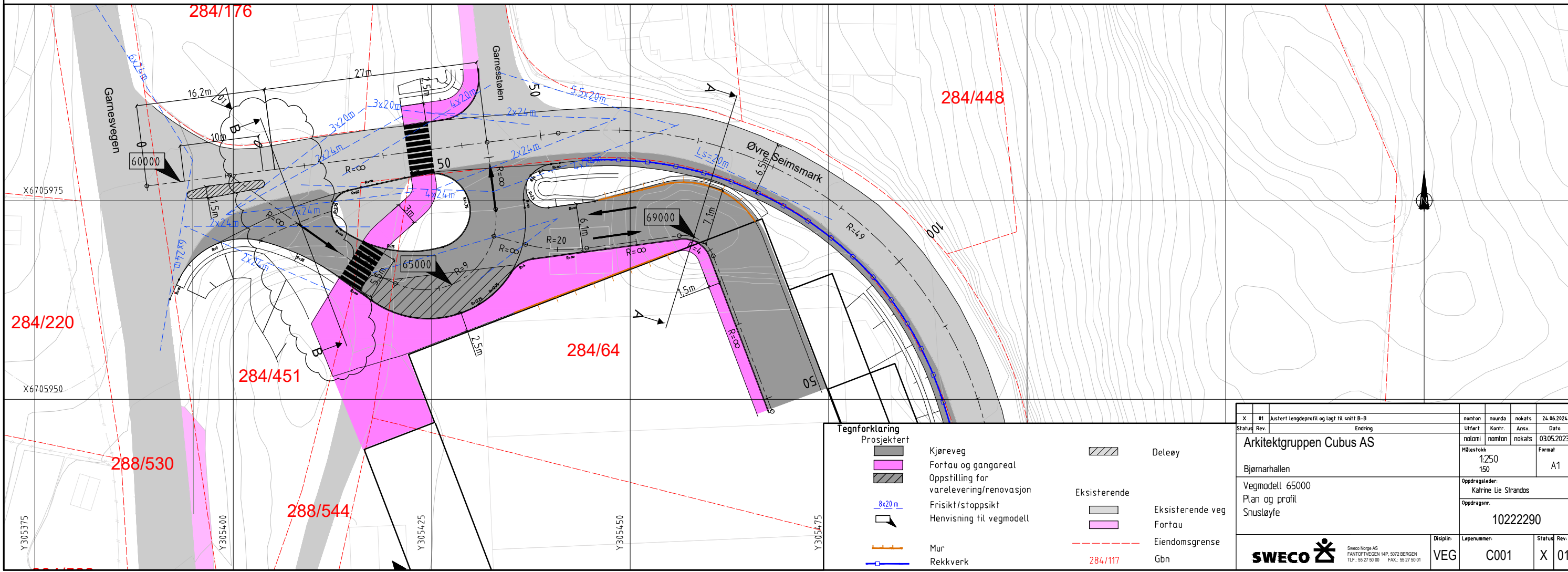
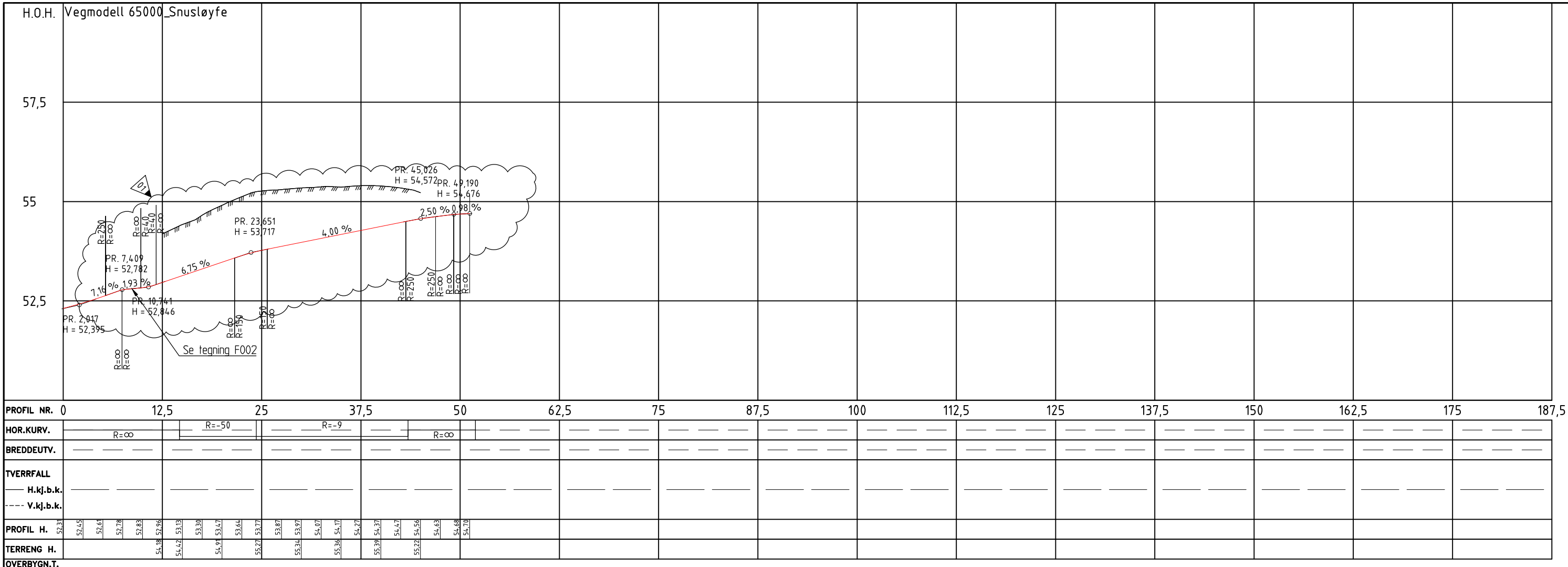

Tegnforklaring	
	Kjøreveg
	Fortau og gangareal
	Oppstilling for varelevering/renovasjon
	Frisikt/stopsikt
	Hensvisning til vegmodell
	Mur
	Rekkverk
	Deleøy
	Eksisterende
	Eksisterende veg
	Fortau
	Eiendomsgrænse
	Gbn

X	01	Justert lengdeprofil og lagt til snitt B-B	nomlon	nourda	nokals	24.06.2024
Status	Rev.	Endring	Utført	Kontr.	Ansv.	Dato
Arkitektgruppen Cubus AS			nomlon	nomlon	nokals	03.05.2023
Bjørnarhallen			Målestokk			Format
Vegmodell 65000			1:250			A1
Plan og profil			150			
Snusløyfe			Oppdragsleder:	Kathrine Lie Strandos		
			Oppdragsnr.	10222290		
SWECO		Sweco Norge AS FANTOFTVEGEN 14P, 5072 BERGEN TLF: 55 27 50 00 FAX: 55 27 50 01	Disiplin:	Løpnummer:	Status:	Rev:
VEG				C001	X	01

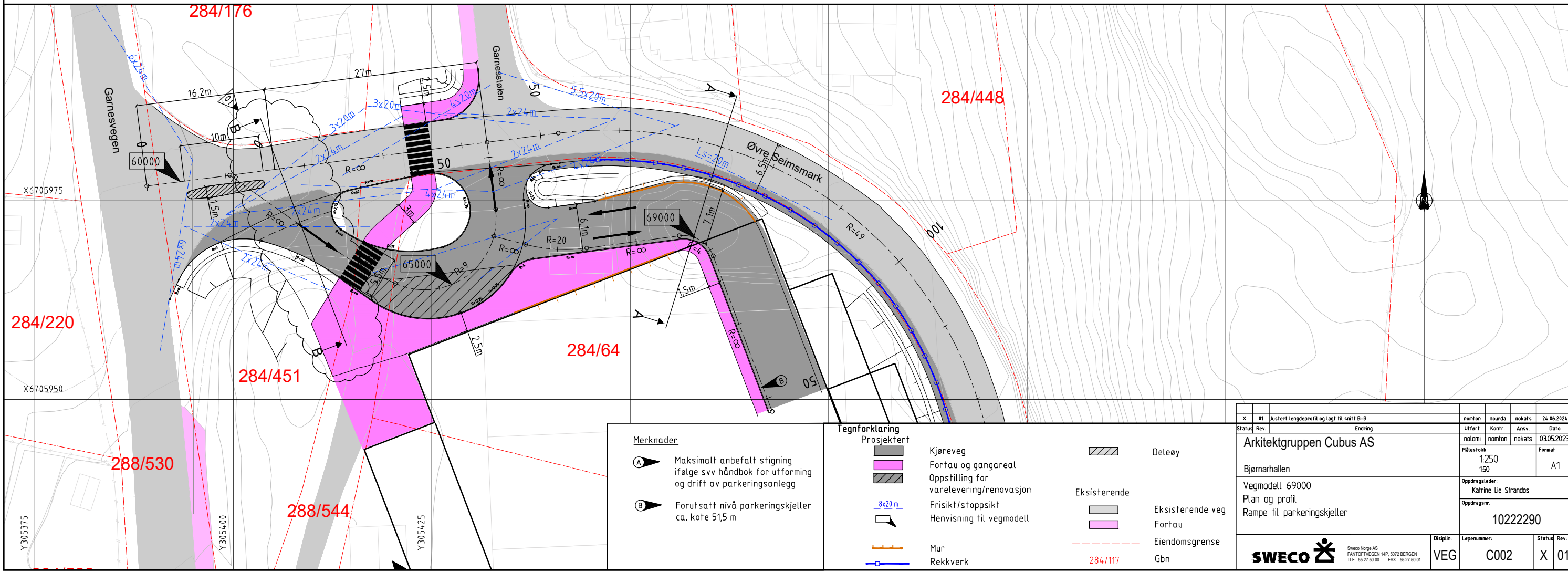
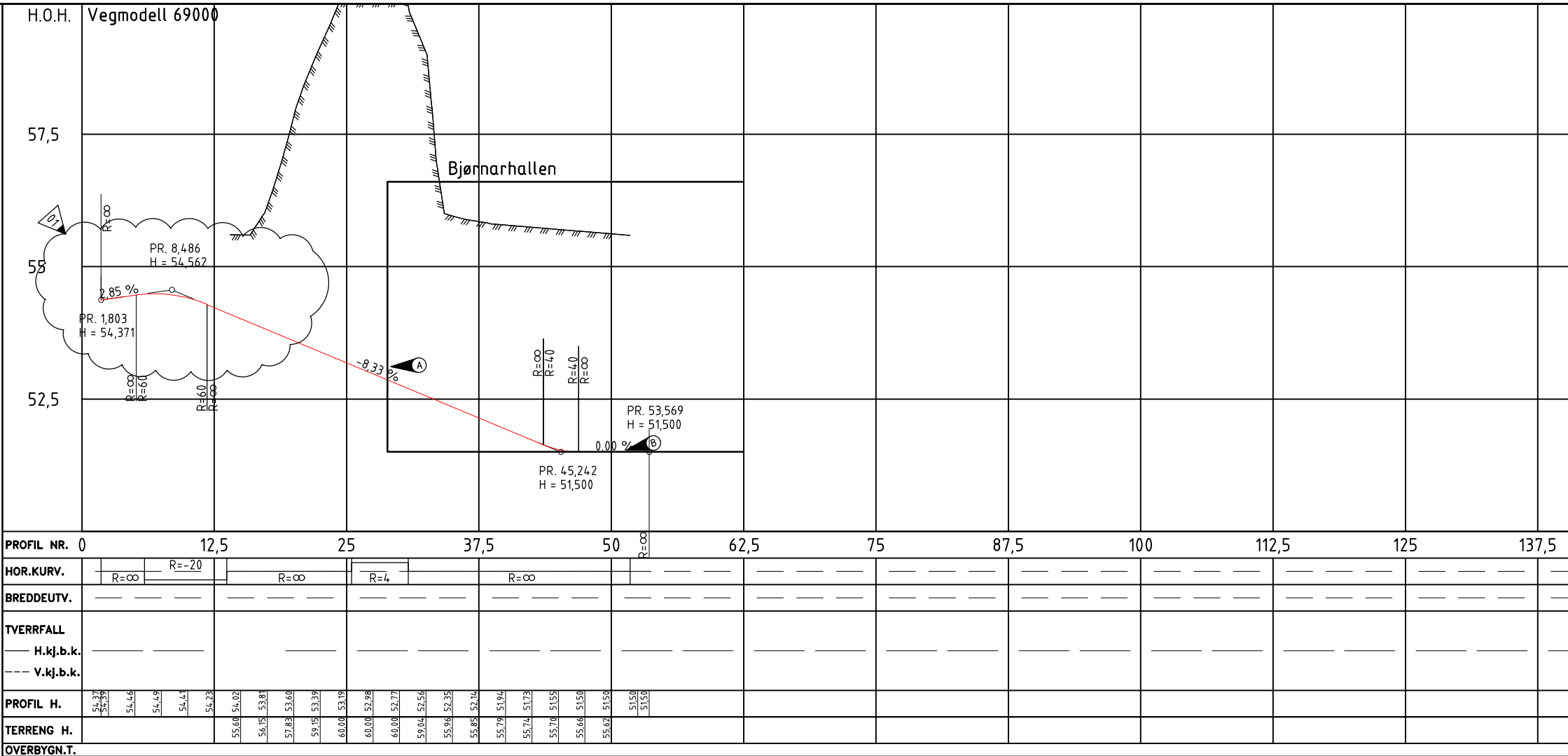

Merknader		Tegnforklaring	
(A) Maksimalt anbefalt stigning ifølge svv håndbok for utforming og drift av parkeringsanlegg		Projektert	
(B) Forutsatt nivå parkeringskjeller ca. kote 51,5 m		Kjøreveg	Deleøy
		Fortau og gangareal	Eksisterende
		Oppstilling for varelevering/renovasjon	Eksisterende veg
		Frisikt/stopsikt	Fortau
		Henvvisning til vegmodell	Eiendomsgrense
		Mur	Gbn
		Rekkverk	

X	Rev.	Endring	nomton	nourda	nokals	24.06.2024
X	01	Justert lengdeprofil og lagt til snitt B-B	Urført	Kantr.	Ansv.	Dato
Arkitektgruppen Cubus AS			ndomi	nomton	nokals	03.05.2023
Bjørnarhallen			Målestokk			Formål
Vegmodell 69000			1:250			A1
Plan og profil			150			
Rampe til parkeringskjeller			Oppdragsleder:			
			Katrine Lie Strandos			
			Oppdragsnr.			
			10222290			
SWECO			Disiplin:	Løpenummer:	Status:	Rev:
FANTOFTVEGEN 14P, 5072 BERGEN TEL: 55 27 50 00 FAX: 55 27 50 01			VEG	C002	X	01

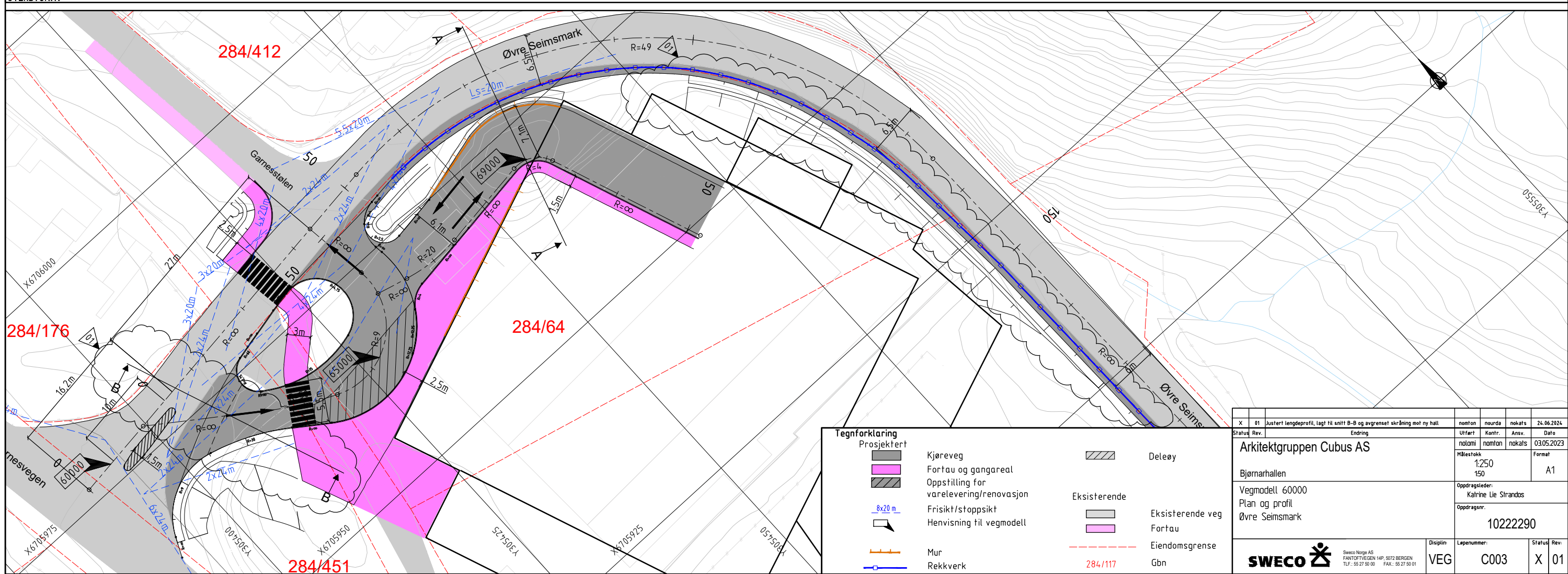
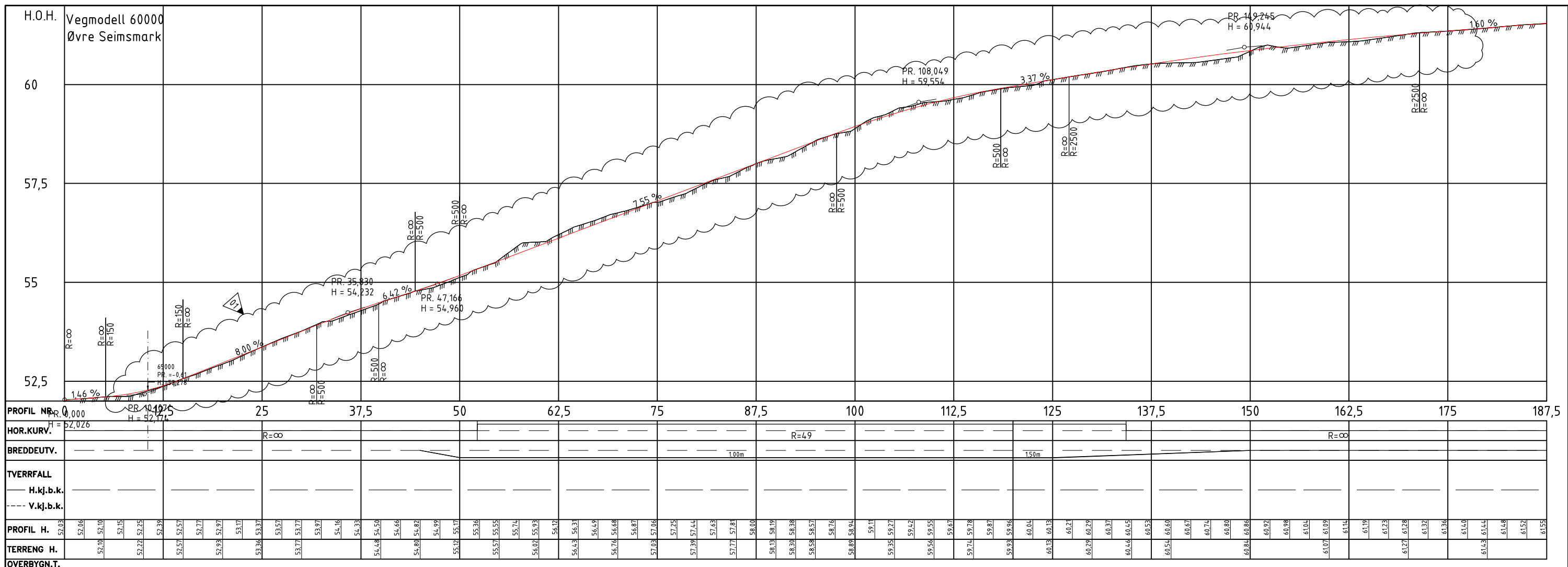

X	01	Justert lengdeprofil, lagt til snitt B-B og avgrenset skråning mot ny hall	nomton	nourda	nokals	24.06.2024
Status	Rev.	Endring	Urført	Kantr.	Ansv.	Dato
Arkitektgruppen Cubus AS			ndomil	nomton	nokals	03.05.2023
Bjørnshallen			Målestokk			Format
Vegmodell 60000			1:250			A1
Plan og profil			150			
Øvre Seimsmark			Oppdragsleder:			
			Katrine Lie Strandos			
			Oppdragsnr.			
			10222290			
SWECO		Sweco Norge AS FANTOFTVEGEN 14P, 5072 BERGEN Tlf.: 55 27 50 00 FAX: 55 27 50 01	Disiplin:	Løpenummer:	Status:	Rev:
VEG		C003	X	01		

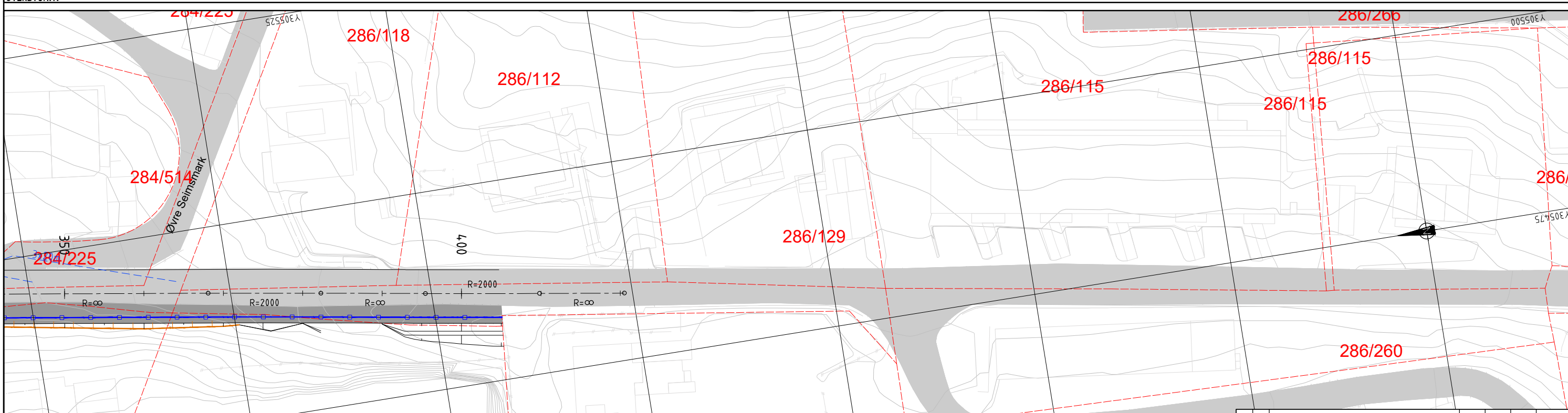
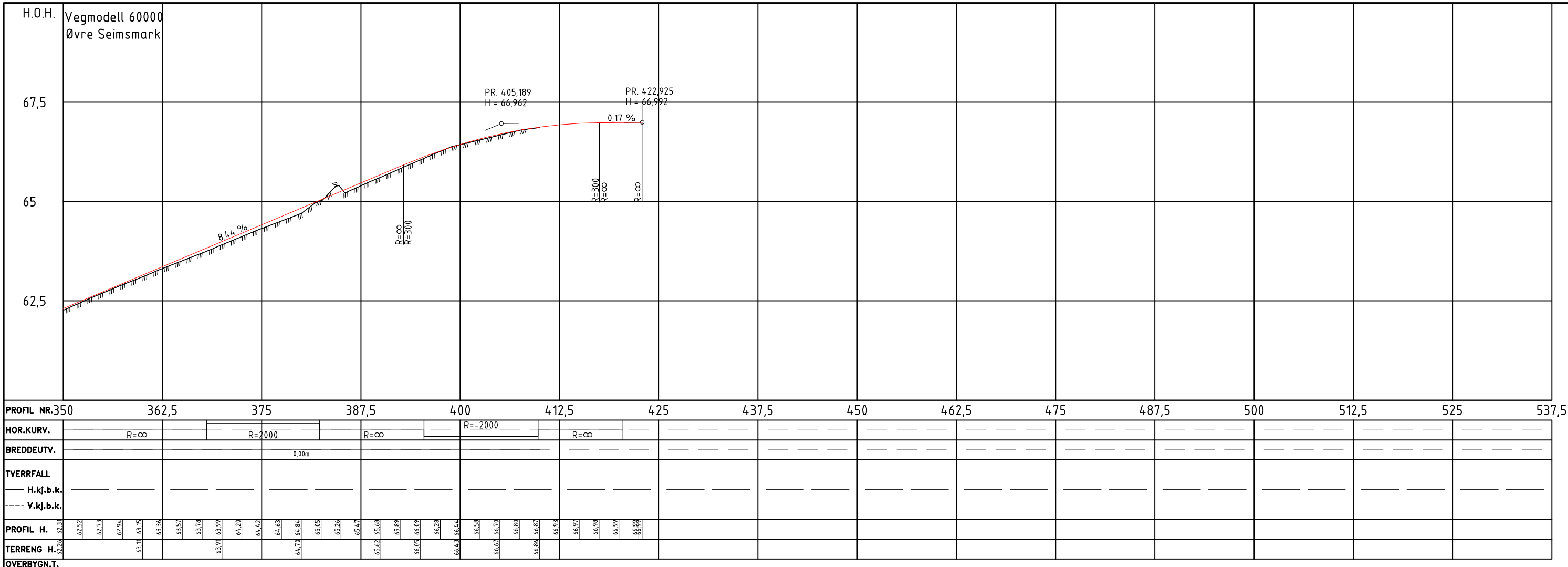

Tegnforklaring	
	Prosjektert
	Kjøreveg
	Fortau og gangareal
	Oppstilling for varelevering/renovasjon
	Frisikt/stopsikt
	Henvvisning til vegmodell
	Mur
	Rekkverk
	Deleoy
	Eksisterende
	Eksisterende veg
	Fortau
	Eiendomsgrense
	Gbn

Status	Rev.	Endring	Urført	Kontr.	Ansv.	Dato
			nomlan	nourda	nokals	24.06.2024
Arkitektgruppen Cubus AS			Målestokk	Format		
Bjørnarhallen			1:250	A1		
Vegmodell 60000			150			
Plan og profil			Oppdragsleder:			
Øvre Seimsmark			Kathrine Lie Strandos			
			Oppdragsnr.			
			10222290			
SWECO			Disiplin:	Løpenummer:	Status:	Rev:
Sweco Norge AS FANTOFTVEGEN 14P, 5072 BERGEN TLF: 55 27 50 00 FAX: 55 27 50 01			VEG	C005	X	00

Snitt A-A

Øvre Seimsmark
Veimodell 60000

Bjørnarhallen

Eks. veikant

Eks. veikant

Eks. veibane

Breiddeutvidelse

5,5

1,0

Rekkverkrom

0,75

73

Støttemur

55

Adkomst til p-kjeller

X	01	Oppdatert Iverssnitt	nomton	nourda	nokals	24.06.2024
Status	Rev.	Endring	Utført	Kontr.	Ansv.	Dato
Arkitektgruppen Cubus AS			nomtom	nomton	nokals	23.02.2023
Bjørnarhallen			Målestokk	1:50	Format	A1
Snitt A-A			Oppdragsleder:		Kathrine Lie Strandos	
			Oppdragsnr.		10222290	
 Sweco Norge AS FANTOFTVEIEN 14P, 5072 BERGEN TLF.: 55 27 50 00 FAX.: 55 27 50 01			Disiplin:	Løpnummer:	Status:	Rev:
			VEG	F001	X	01

Snitt B-B

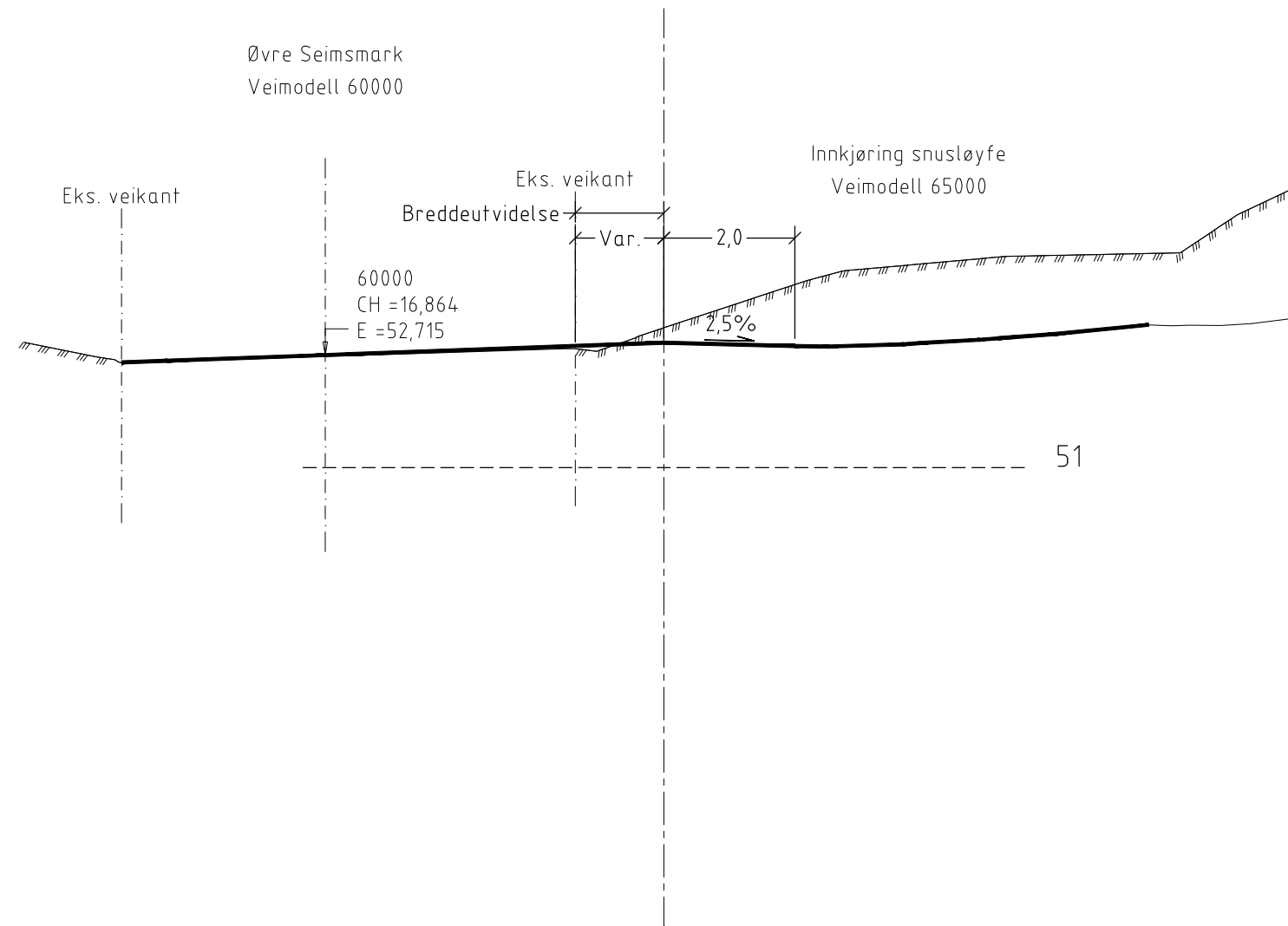

Status	Rev.	Endring	Utført	Kontr.	Ansv.	Dato
			namlon	nourda	nokals	24.06.2024
Arkitektgruppen Cubus AS			Målestokk	1:50	Format	A1
Bjørnarhallen			Oppdragsleder: Kathrine Lie Strandos			
Snitt B-B			Oppdragsnr. 10222290			
 <small>Sweco Norge AS FANTOFVEISEN 14P, 5072 BERGEN TLF.: 55 27 50 00 FAX.: 55 27 50 01</small>			Disiplin:	Løpenummer:	Status:	Rev:
			VEG	F002	X	00

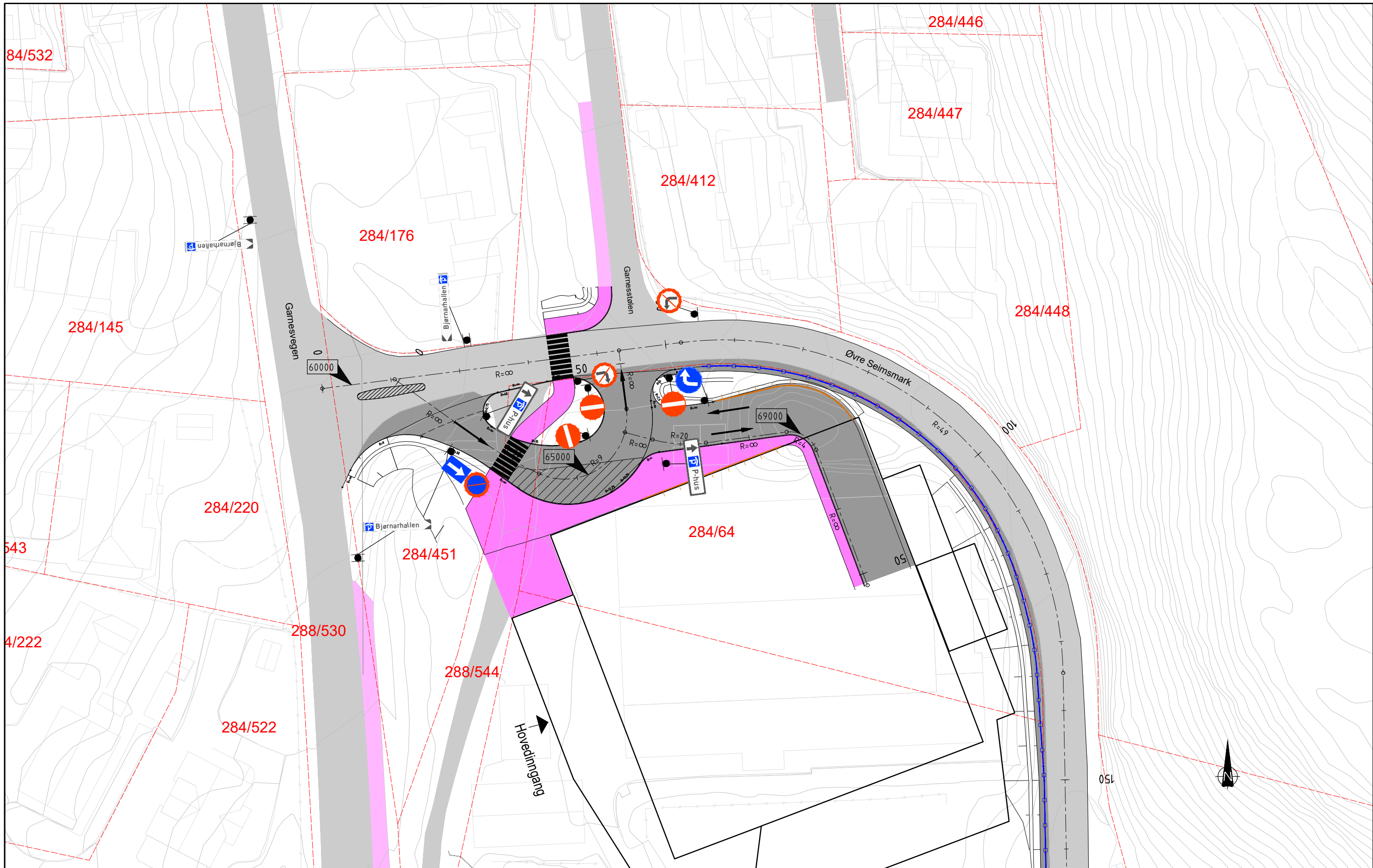

Tegnforklaring		Eksisterende	
	Kjøreveg		Eksisterende veg
	Fortau og gangareal		Fortau
	Oppstilling for varelevering/renovasjon		Eiendomsgrense
	8x20 m Frisikt/stopsikt		Gbn
	Hensvisning til vegmodell		
	Mur		
	Rekkverk		

Status	Rev.	Endring	Utferd	Kontr.	Ansv.	Dato
			nomlan	nourda	nokals	24.06.2024
Arkitektgruppen Cubus AS			Målestokk	1:250		Format
Bjornarhallen			Oppdragsleder:		A1	
Skiltplan			Katrine Lie Strandos			
Skisse for skilting av kjøremønster			Oppdragsnr.		10222290	
SWECO			Disiplin:	Løpenummer:	Status:	Rev:
Sweco Norge AS FANTOFTVEGEN 14P, 5072 BERGEN TLF.: 55 27 50 00 FAX.: 55 27 50 01			VEG	L001	X	00

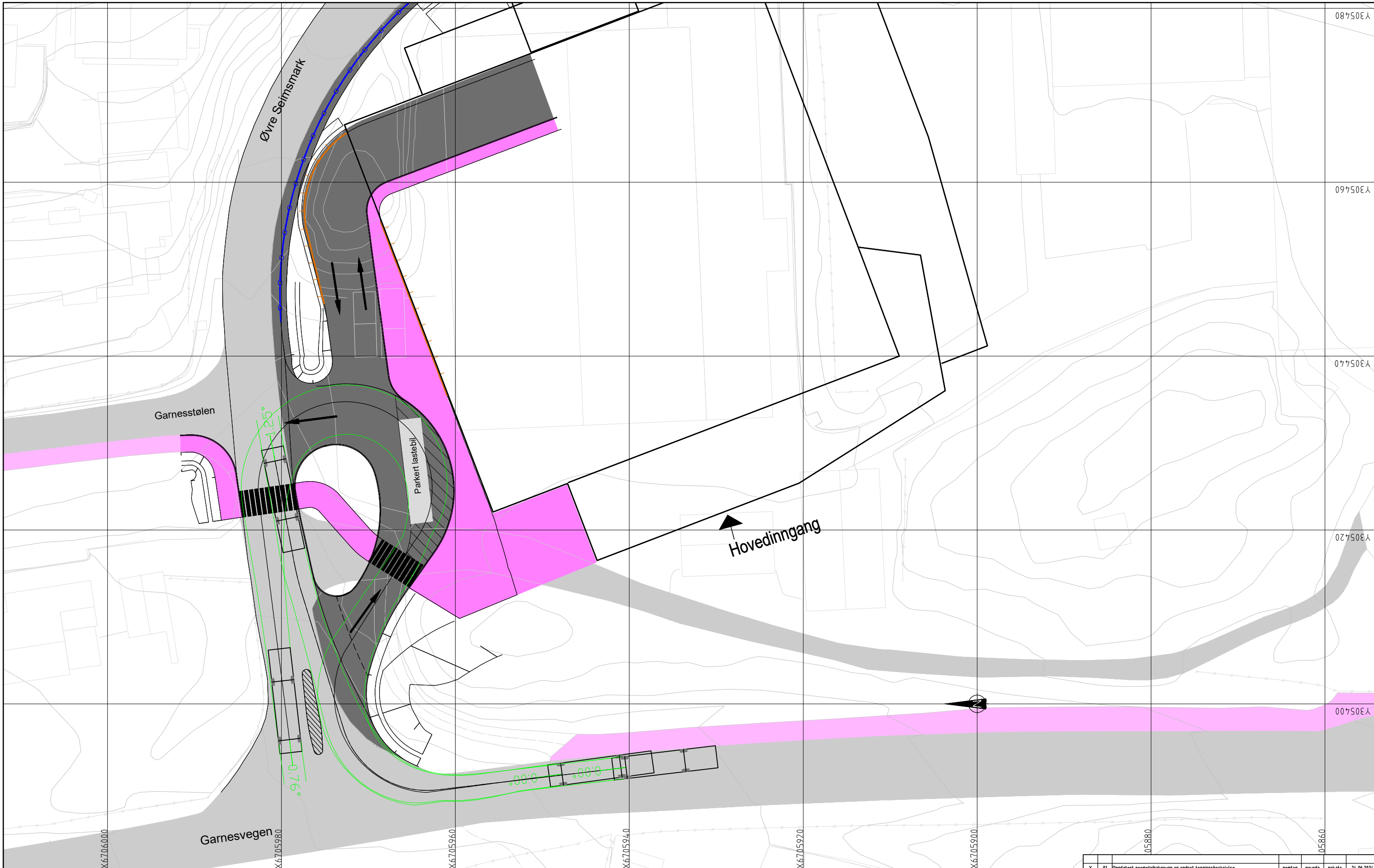

Tegnforklaring

- Prosjekttert
- Kjøreveg
 - Fortau og gangareal
 - Oppstilling for varelevering/renovasjon
 - Mur
 - Rekkeverk
 - Deleøy
 - Eksisterende veg
 - Eksisterende Fortau

X	01	Oppdatert geometribakgrunn og endret tegningsbeskrivelse	nomton	nourda	nokals	24.06.2024
Status	Rev.	Endring	Utført	Kontr.	Ansv.	Dato
Arkitektgruppen Cubus AS			nomtom	nomton	nokals	03.05.2023
Bjørnarhallen			Målestokk	Format		A1
Vegmodell 65000 og 69000			Oppdragsleder:			
Spøringsanalyse lastebil			Kathrine Lie Strandos			
Snusløyte			Oppdragsnr.			
			10222290			
Sweco Norge AS FANTOFTVEGEN 14P, 5072 BERGEN TLF.: 55 27 50 00 FAX.: 55 27 50 01			Disiplin:	Løpenummer:	Status:	Rev:
VEG			Spring 1-L	X	01	

08750EΛ
 09750EΛ
 07750EΛ
 02750EΛ
 00750EΛ

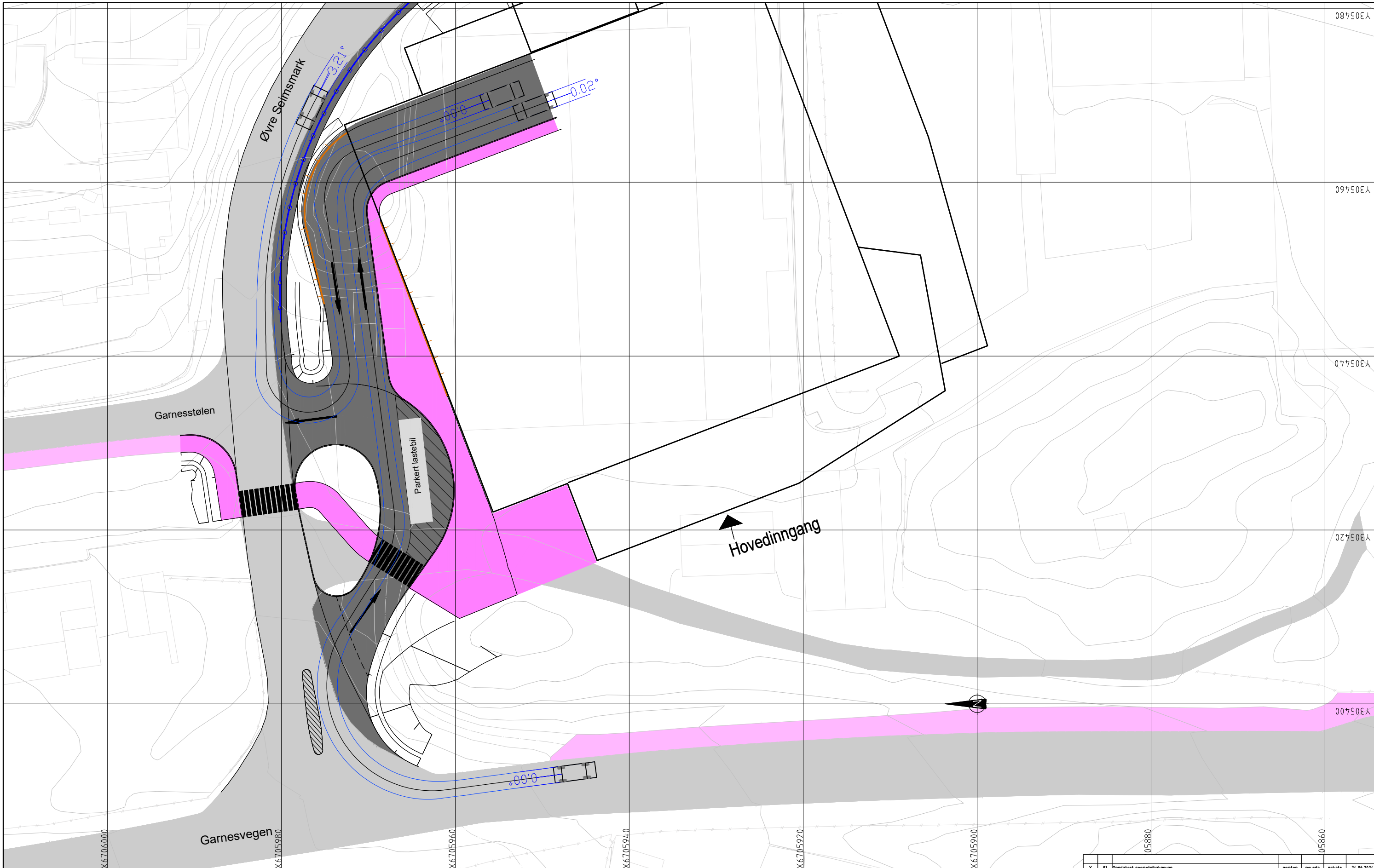

Tegnforklaring

- Prosjekttert
- Kjøreveg
 - Fortau og gangareal
 - Oppstilling for varelevering/renovasjon
 - Mur
 - Rekkeverk
 - Deleøy
 - Eksisterende veg
 - Eksisterende Fortau

X	01	Oppdatert geometribakgrunn	nomin	nourda	nokals	24.06.2024
Status	Rev.	Endring	Utført	Kontr.	Ansv.	Dato
Arkitektgruppen Cubus AS			noloml	nomlon	nokals	03.05.2023
Bjørnarhallen			Målestokk	Format		A1
Vegmodell 65000 og 69000			Oppdragsleder:			
Spøringsanalyse personbil			Kathrine Lie Strandos			
Snuslyfte og rampe til parkeringskjeller			Oppdragsnr.			
			10222290			
SWECO Sweco Norge AS FANTOFTVEGEN 14P, 5072 BERGEN TLF.: 55 27 50 00 FAX.: 55 27 50 01			Disiplin:	Lepe nummer:	Status:	Rev:
VEG			Spring 1-P	X	01	

08750EΛ
09750EΛ
07750EΛ
02750EΛ
00750EΛ

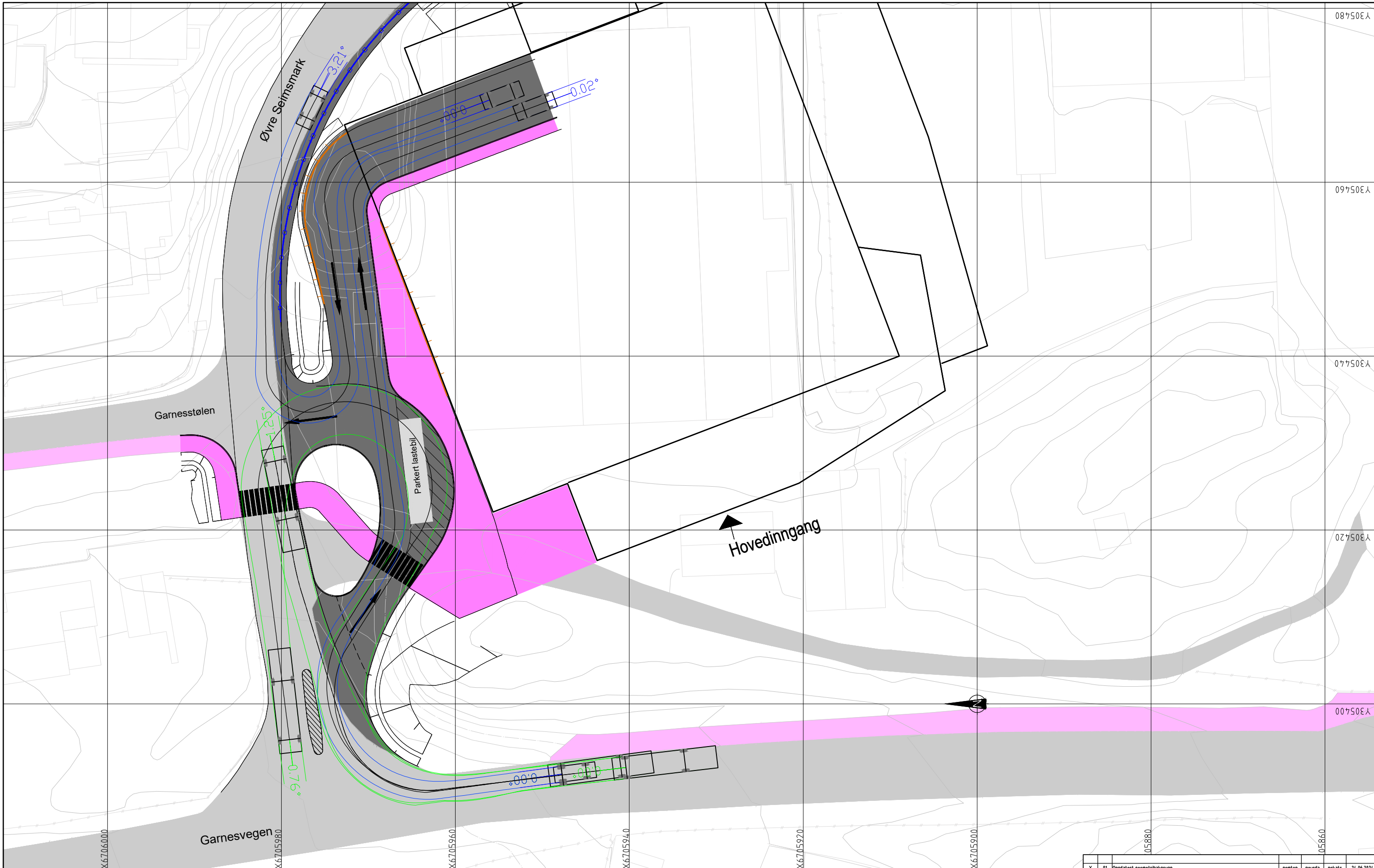

Tegnforklaring

- Prosjekttert
- Kjøreveg
 - Fortau og gangareal
 - Oppstilling for varelevering/renovasjon
 - Mur
 - Rekkeverk
 - Deleøy
 - Eksisterende veg
 - Fortau

X	01	Oppdatert geometribakgrunn		nomton	nourda	nokals	24.06.2024
Status	Rev.	Endring		Utført	Kontr.	Ansv.	Dato
Arkitektgruppen Cubus AS				nomtom	nomton	nokals	03.05.2023
Bjørnarhallen				Målestokk	1:200		Format
Vegmodell 65000 og 69000				Oppdragsleder:			
Spøringsanalyse lastebil og personbil				Kathrine Lie Strandos			
Snuslyfte og rampe til parkeringskjeller				Oppdragsnr.			
				10222290			
Sweco Norge AS FANTOFTVEGEN 14P, 5072 BERGEN TLF.: 55 27 50 00 FAX.: 55 27 50 01			Disiplin:	Løpenummer:		Status:	Rev.
VEG			Spring 1		X		01

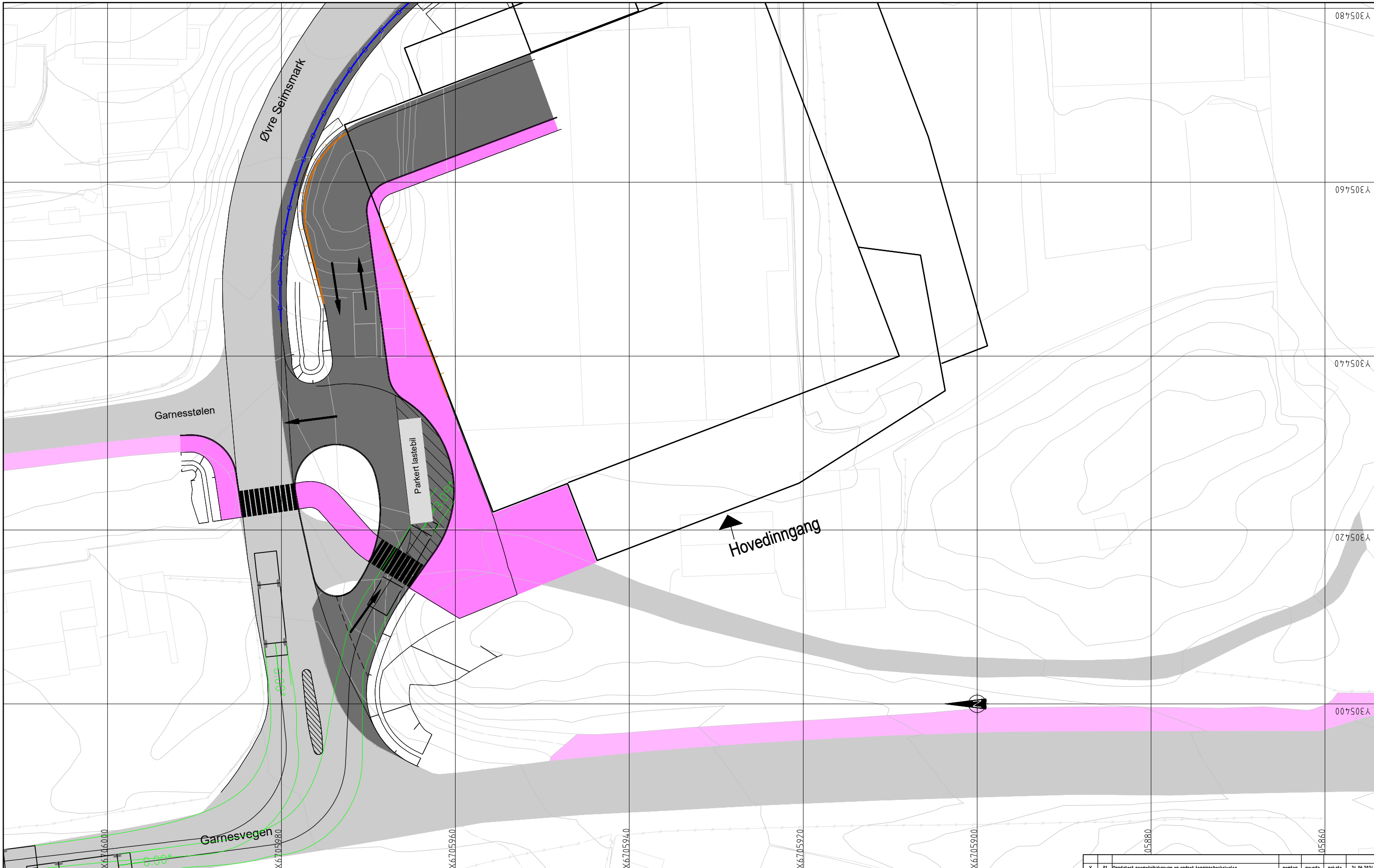

Tegnforklaring

- Prosjekttert
- Kjøreveg
 - Fortau og gangareal
 - Oppstilling for varelevering/renovasjon
 - Mur
 - Rekkeverk
 - Deleøy
 - Eksisterende veg
 - Eksisterende Fortau

X	01	Oppdatert geometribakgrunn og endret tegningsbeskrivelse	nomton	nourda	nokals	24.06.2024
Status	Rev.	Endring	Utført	Kontr.	Ansv.	Dato
Arkitektgruppen Cubus AS			nomtom	nomton	nokals	03.05.2023
Bjørnarhallen			Målestokk	1:200		Format
Vegmodell 65000 og 69000						A1
Spøringsanalyse lastebil			Oppdragsleder:		Kalrine Lie Strandos	
Snusløyte			Oppdragsnr.		10222290	
Sweco Norge AS FANTOFVESSEN 14P, 5072 BERGEN TLF.: 55 27 50 00 FAX.: 55 27 50 01			Disiplin:	Løpenummer:	Status	Rev.
VEG			Spring 3		X	01

08750EΛ
 09750EΛ
 07750EΛ
 02750EΛ
 00750EΛ

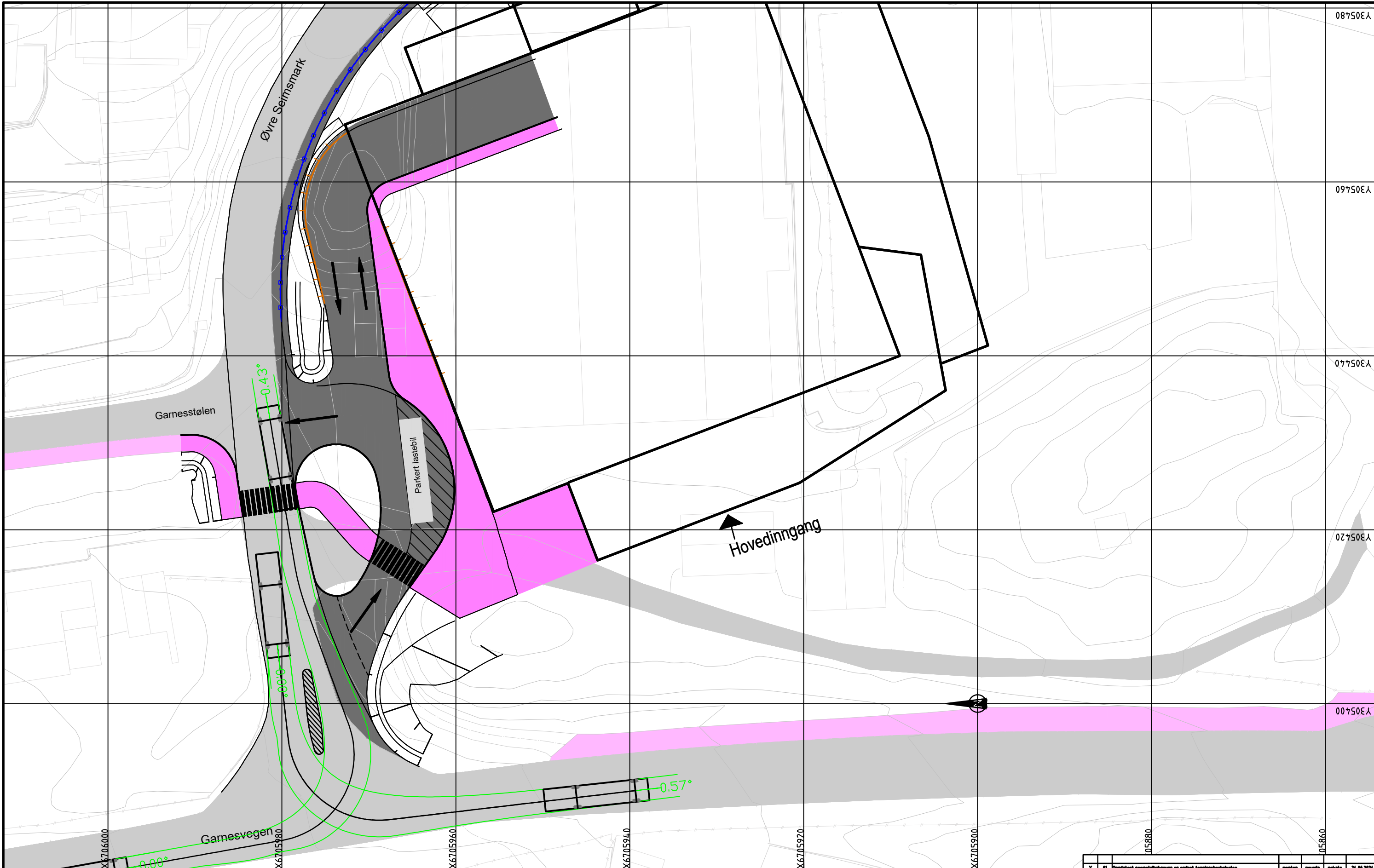



Tegnforklaring

Prosjekttert

- Kjøreveg
- Fortau og gangareal
- Oppstilling for varelevering/renovasjon
- Mur
- Rekkeverk
- Deleøy
- Eksisterende veg
- Eksisterende Fortau

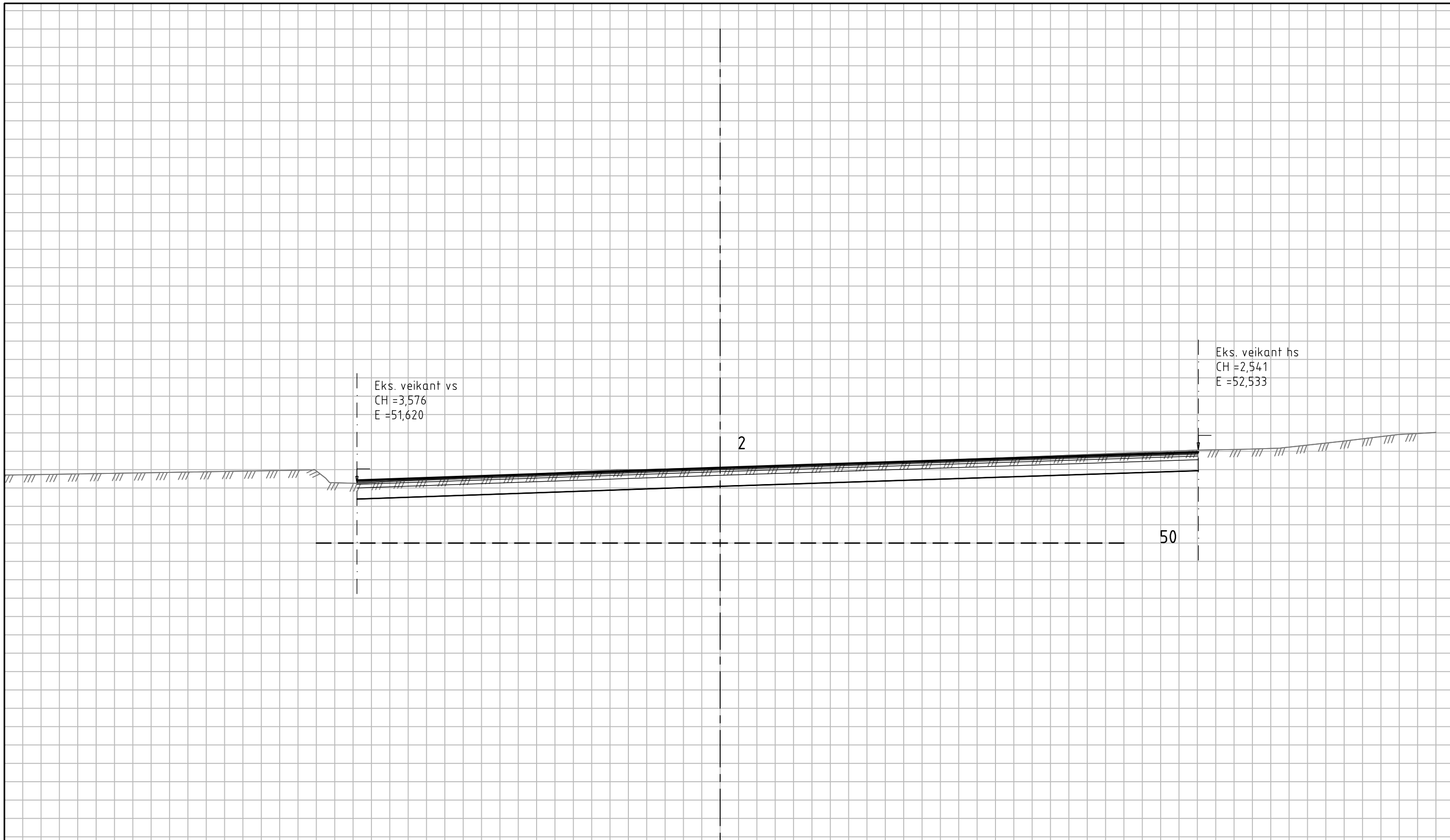
X	01	Oppdatert geometriplan og endret fagingsbeskrivelse	nr/rev	nr/rev	nr/rev	24.06.2024
Status		Endring				
Arkitektgruppen Cubus AS			Urfart	Kant.	Anv.	Date
			nå/rev	nå/rev	nå/rev	03.05.2023
Bjørnarhallen			Målestokk	Format		
Vegmodell 65000 og 69000			1:200	A1		
Spøringsanalyse lastebil			Oppdragsleder:			
Øvre Seimsmark			Kathrine Lie Strands			
			Oppdragsnr.:			
			10222290			
SWECO		Sweco Norge AS FANTOFTVEGEN 14P, 5072 BERGEN Tlf.: 55 27 50 00 Fax: 55 27 50 01	Disiplin	Løpnummer	Status	Rev
VEG		Spring 4	X	01		



Status	Rev.	Endring	Utført	Kontr.	Ansv.	Dato
		Arkitektgruppen Cubus AS	nomton	nourda	nokats	20.06.2024
		Bjørnarhallen	Målestokk	1:100		Format A3
		Vegmodell 60000	Oppdragsleder: Kathrine Lie Strandos			
		Tverrprofiler	Oppdragsnr. 10222290			
		Øvre Seimsmark	Disiplin:	Løpnummer:	Status	Rev:
		SWECO 	VEG	U001	X	00
		<small>Sweco Norge AS FANTOFTVEGEN 14P, 5072 BERGEN TLF.: 55 27 50 00 FAX.: 55 27 50 01</small>				

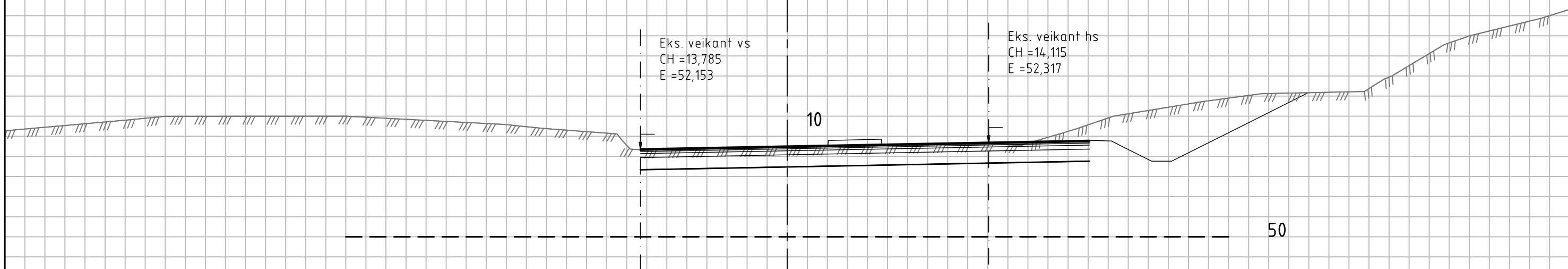

Status	Rev.	Endring	Utført	Kontr.	Ansv.	Dato
		Arkitektgruppen Cubus AS	nomton	nourda	nokats	20.06.2024
		Bjørnarhallen	Målestokk	1:100		Format A3
		Vegmodell 60000	Oppdragsleder: Kathrine Lie Strandos			
		Tverrprofiler	Oppdragsnr. 10222290			
		Øvre Seimsmark	Disiplin:	Løpnummer:	Status	Rev:
		SWECO 	VEG	U002	X	00
		<small>Sweco Norge AS FANTOFVEGEN 14P, 5072 BERGEN TLF.: 55 27 50 00 FAX.: 55 27 50 01</small>				

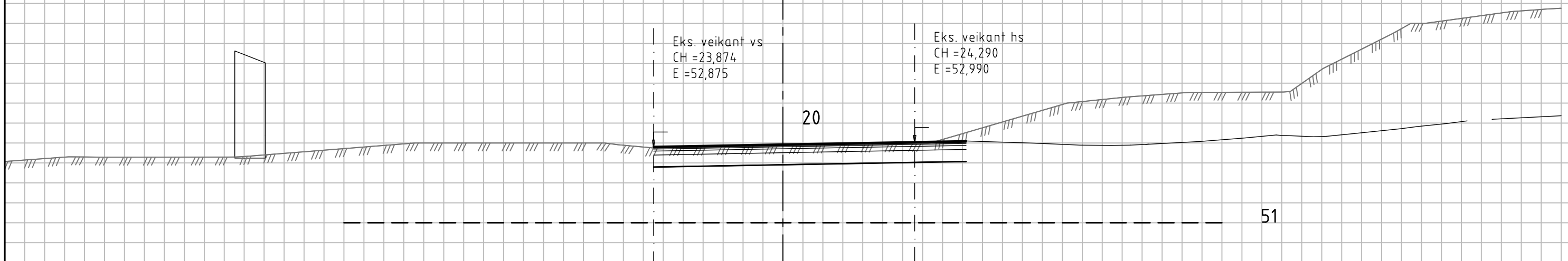

Status	Rev.	Endring	Utført	Kontr.	Ansv.	Dato
		Arkitektgruppen Cubus AS	nomton	nourda	nokats	20.06.2024
		Bjørnarhallen	Målestokk	1:100		Format A3
		Vegmodell 60000	Oppdragsleder: Kathrine Lie Strandos			
		Tverrprofiler	Oppdragsnr. 10222290			
		Øvre Seimsmark	Disiplin:	Løpnummer:	Status	Rev:
		SWECO 	VEG	U003	X	00
		<small>Sweco Norge AS FANTOFTVEGEN 14P, 5072 BERGEN TLF.: 55 27 50 00 FAX.: 55 27 50 01</small>				

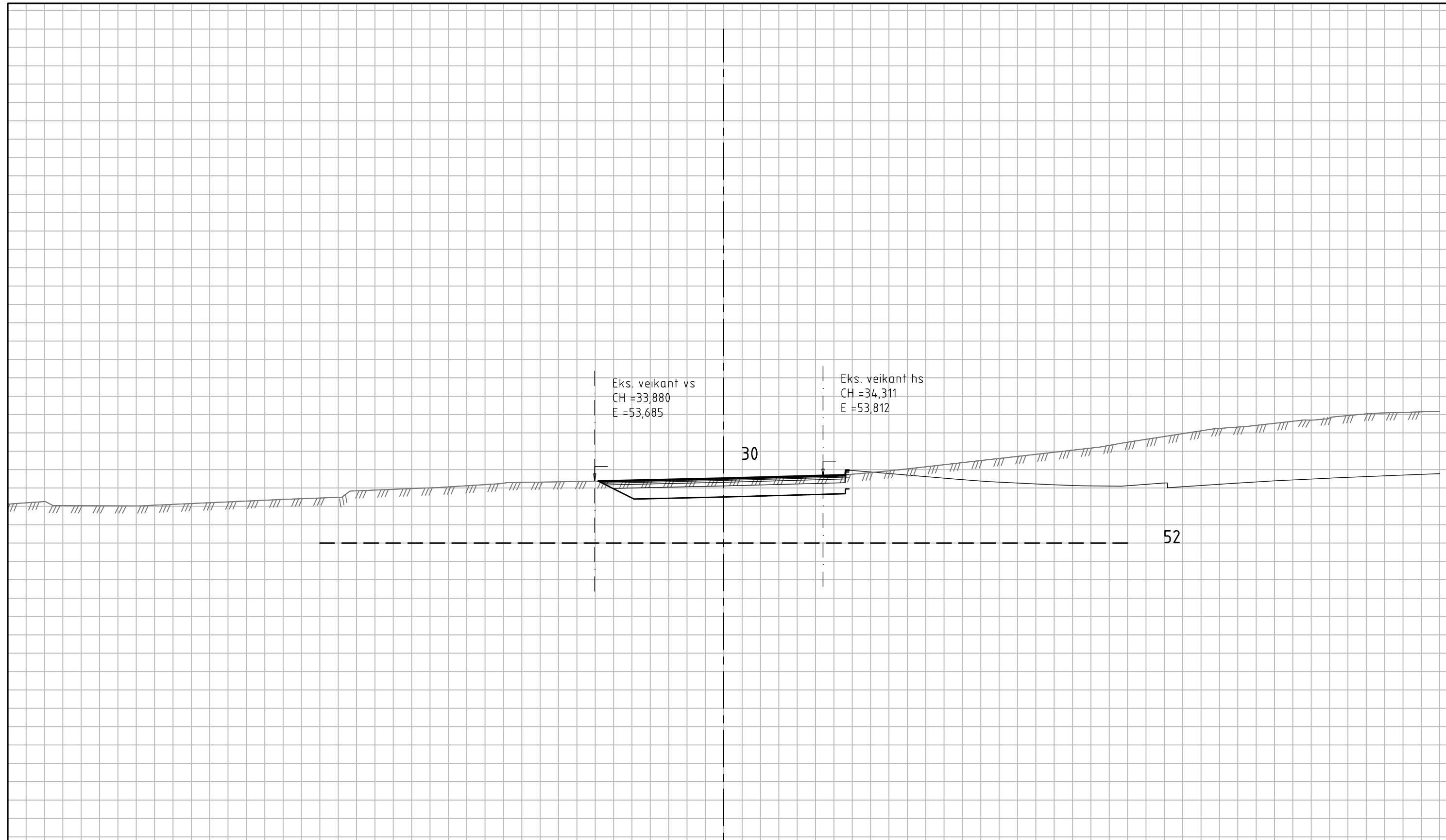

Status	Rev.	Endring	Utført	Kontr.	Ansv.	Dato
Arkitektgruppen Cubus AS			nomton	nourda	nokats	20.06.2024
Bjørnarhallen			Målestokk	1:100		Format A3
Vegmodell 60000			Oppdragsleder: Kathrine Lie Strandos			
Tverrprofiler			Oppdragsnr. 10222290			
Øvre Seimsmark			Disiplin:	Løpnummer:	Status	Rev:
SWECO 		Sweco Norge AS FANTOFVEGEN 14P, 5072 BERGEN TLF.: 55 27 50 00 FAX.: 55 27 50 01	VEG	U004	X	00

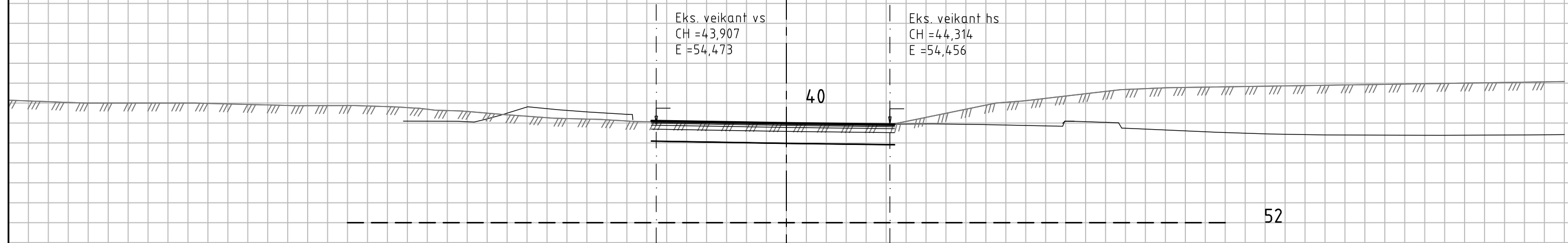

Status	Rev.	Endring	Utført	Kontr.	Ansv.	Dato
		Arkitektgruppen Cubus AS	nomton	nourda	nokats	20.06.2024
		Bjørnarhallen	Målestokk	1:100		Format A3
		Vegmodell 60000	Oppdragsleder: Kathrine Lie Strandos			
		Tverrprofiler	Oppdragsnr. 10222290			
		Øvre Seimsmark	Disiplin:	Løpnummer:	Status	Rev:
		SWECO 	VEG	U005	X	00
		<small>Sweco Norge AS FANTOFTVEGEN 14P, 5072 BERGEN TLF.: 55 27 50 00 FAX.: 55 27 50 01</small>				

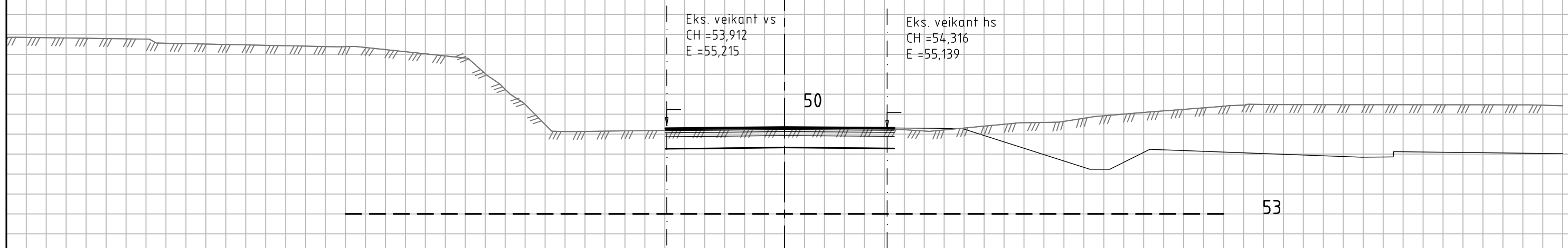

Status	Rev.	Endring	Utført	Kontr.	Ansv.	Dato
Arkitektgruppen Cubus AS			nomton	nourda	nokats	20.06.2024
Bjørnarhallen			Målestokk	1:100		Format A3
Vegmodell 60000			Oppdragsleder: Kathrine Lie Strandos			
Tverrprofiler			Oppdragsnr. 10222290			
Øvre Seimsmark			Disiplin:	Løpnummer:	Status	Rev:
SWECO 		Sweco Norge AS FANTOFVEGEN 14P, 5072 BERGEN TLF.: 55 27 50 00 FAX.: 55 27 50 01	VEG	U006	X	00

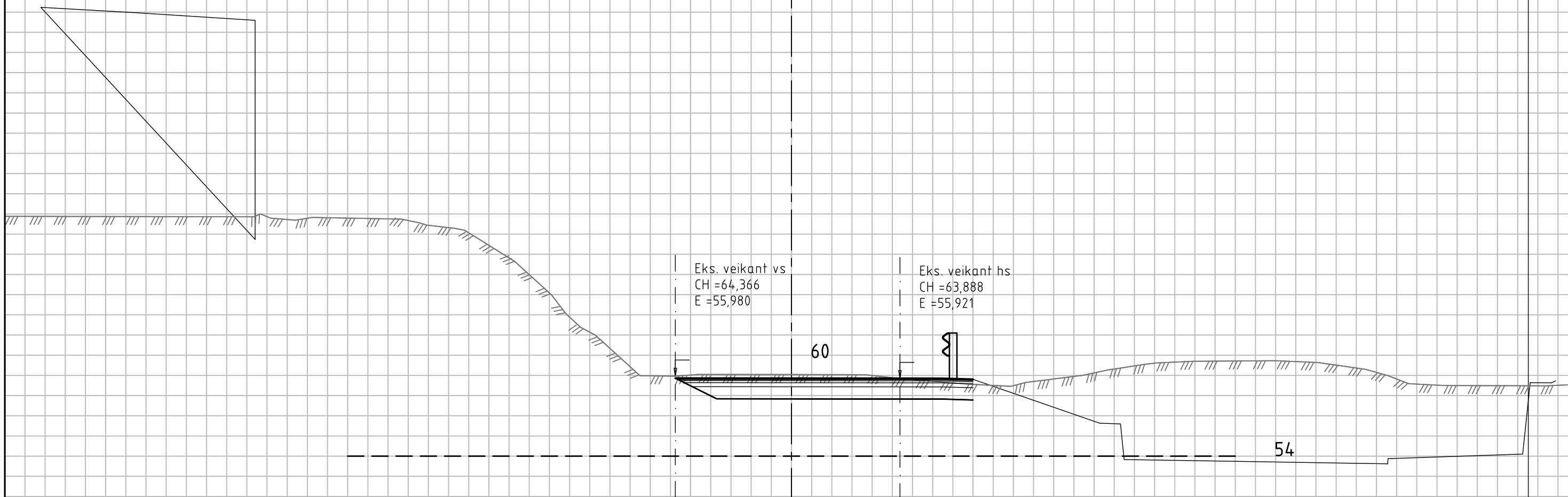

Eks. veikant vs
CH =64,366
E =55,980

Eks. veikant hs
CH =63,888
E =55,921

60

54

Status	Rev.	Endring	Utført	Kontr.	Ansv.	Dato
		Arkitektgruppen Cubus AS	nomton	nourda	nokats	20.06.2024
		Bjørnarhallen	Målestokk	1:100		Format A3
		Vegmodell 60000	Oppdragsleder: Kathrine Lie Strandos			
		Tverrprofiler	Oppdragsnr. 10222290			
		Øvre Seimsmark	Disiplin:	Løpenummer:	Status	Rev:
		SWECO 	VEG	U007	X	00
		<small>Sweco Norge AS FANTOFTVEGEN 14P, 5072 BERGEN TLF.: 55 27 50 00 FAX.: 55 27 50 01</small>				

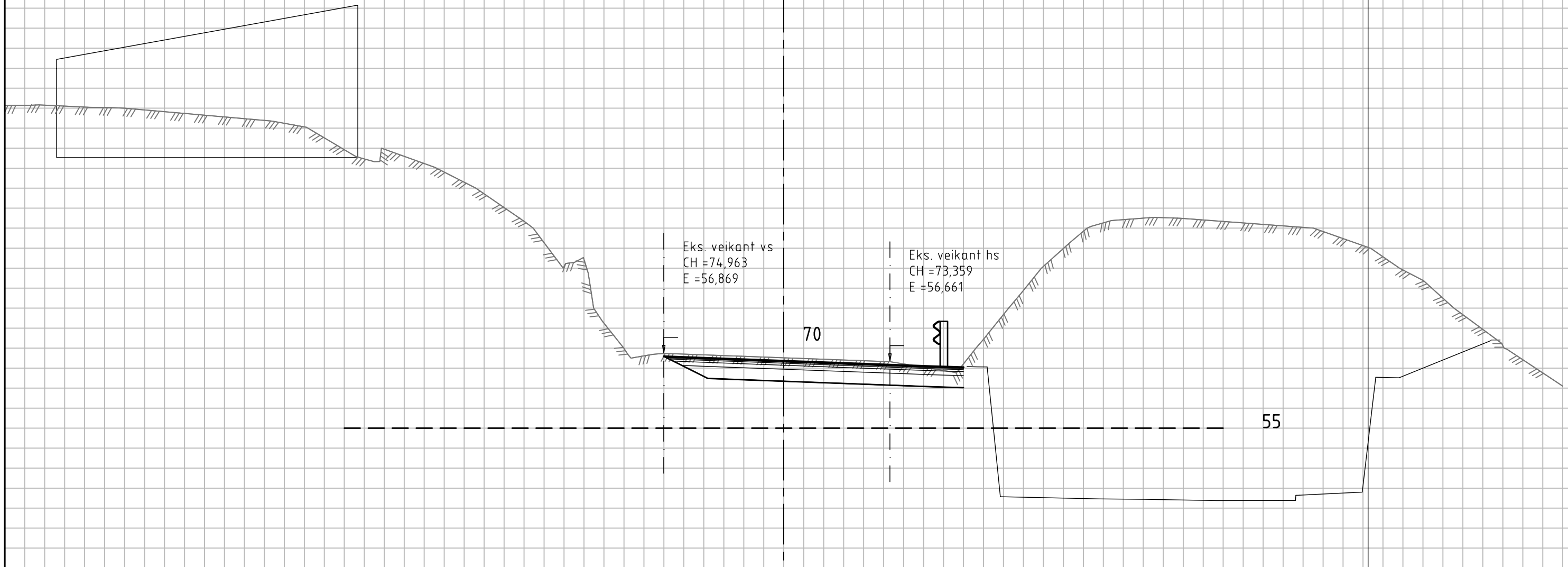

Status	Rev.	Endring	Utført	Kontr.	Ansv.	Dato
		Arkitektgruppen Cubus AS	nomton	nourda	nokats	20.06.2024
		Bjørnarhallen	Målestokk	1:100		Format A3
		Vegmodell 60000	Oppdragsleder: Kathrine Lie Strandos			
		Tverrprofiler	Oppdragsnr. 10222290			
		Øvre Seimsmark	Disiplin:	Løpnummer:	Status	Rev:
		SWECO 	VEG	U008	X	00
		<small>Sweco Norge AS FANTOFTVEGEN 14P, 5072 BERGEN TLF.: 55 27 50 00 FAX.: 55 27 50 01</small>				

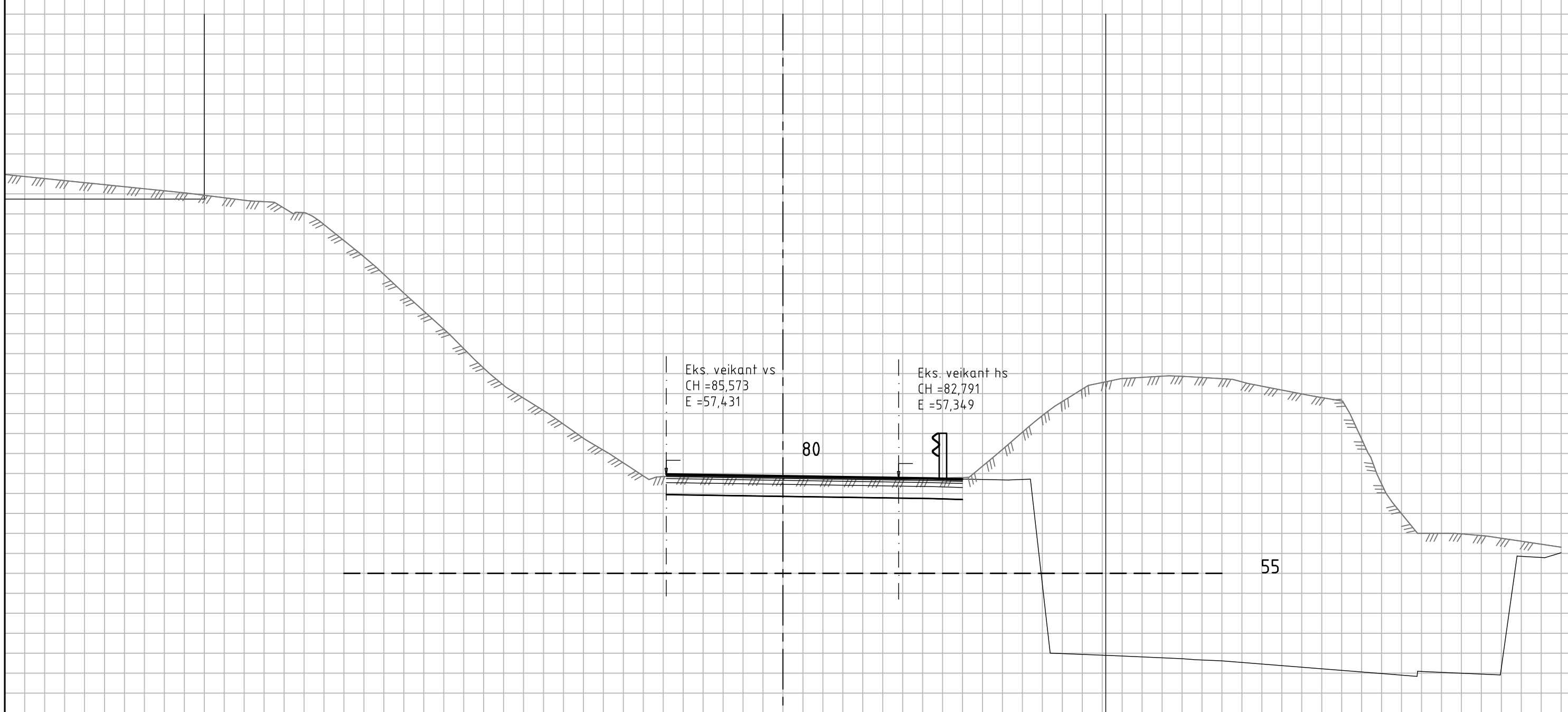

Eks. veikant vs
CH =85,573
E =57,431

Eks. veikant hs
CH =82,791
E =57,349

80

55

Status	Rev.	Endring	Utført	Kontr.	Ansv.	Dato
Arkitektgruppen Cubus AS			nomton	nourda	nokats	20.06.2024
Bjørnarhallen			Målestokk	1:100		Format A3
Vegmodell 60000			Oppdragsleder:	Kathrine Lie Strandos		
Tverrprofiler			Oppdragsnr.	10222290		
Øvre Seimsmark			Disiplin:	Løpnummer:	Status	Rev.
SWECO 			VEG	U009	X	00
<small>Sweco Norge AS FANTOFTVEGEN 14P, 5072 BERGEN TLF.: 55 27 50 00 FAX.: 55 27 50 01</small>						

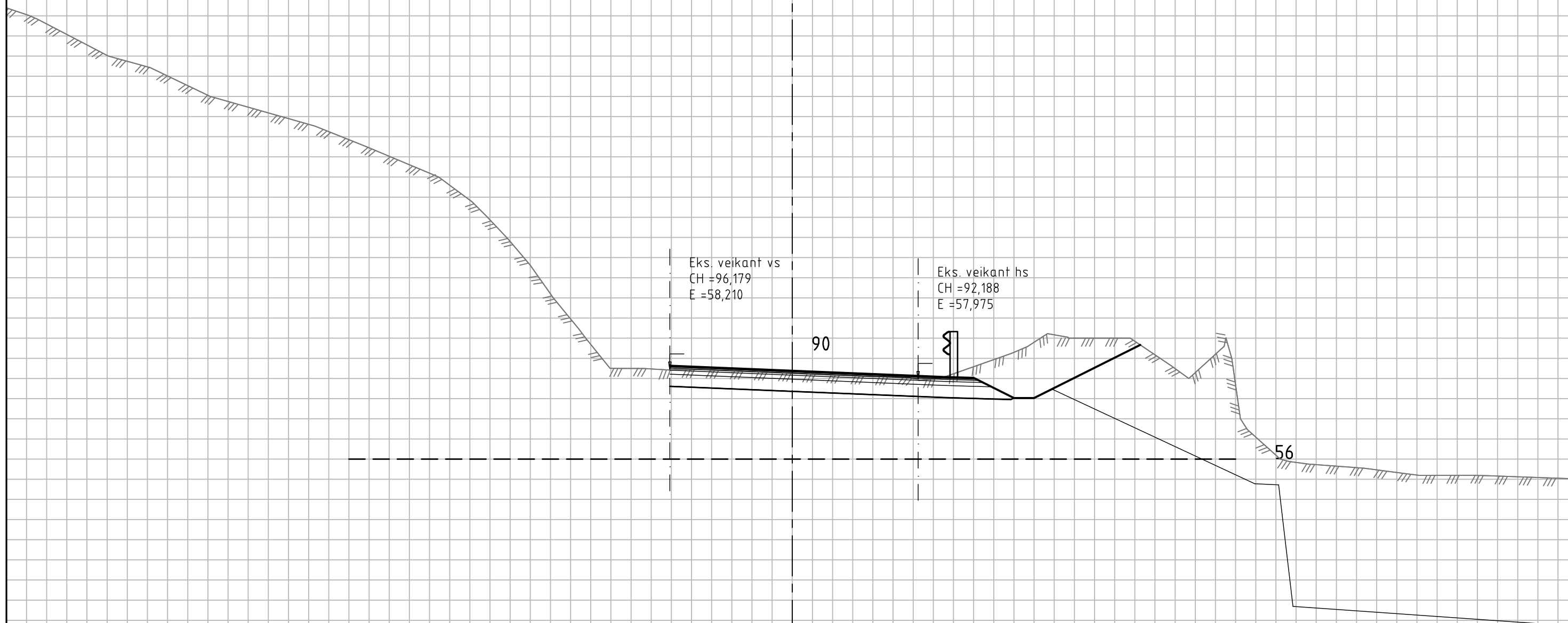

Status	Rev.	Endring	Utført	Kontr.	Ansv.	Dato
		Arkitektgruppen Cubus AS	nomton	nourda	nokats	20.06.2024
		Bjørnarhallen	Målestokk	1:100		Format A3
		Vegmodell 60000	Oppdragsleder: Kathrine Lie Strandos			
		Tverrprofiler	Oppdragsnr. 10222290			
		Øvre Seimsmark	Disiplin:	Løpnummer:	Status	Rev:
		SWECO 	VEG	U010	X	00
		Sweco Norge AS FANTOFTVEGEN 14P, 5072 BERGEN TLF.: 55 27 50 00 FAX.: 55 27 50 01				

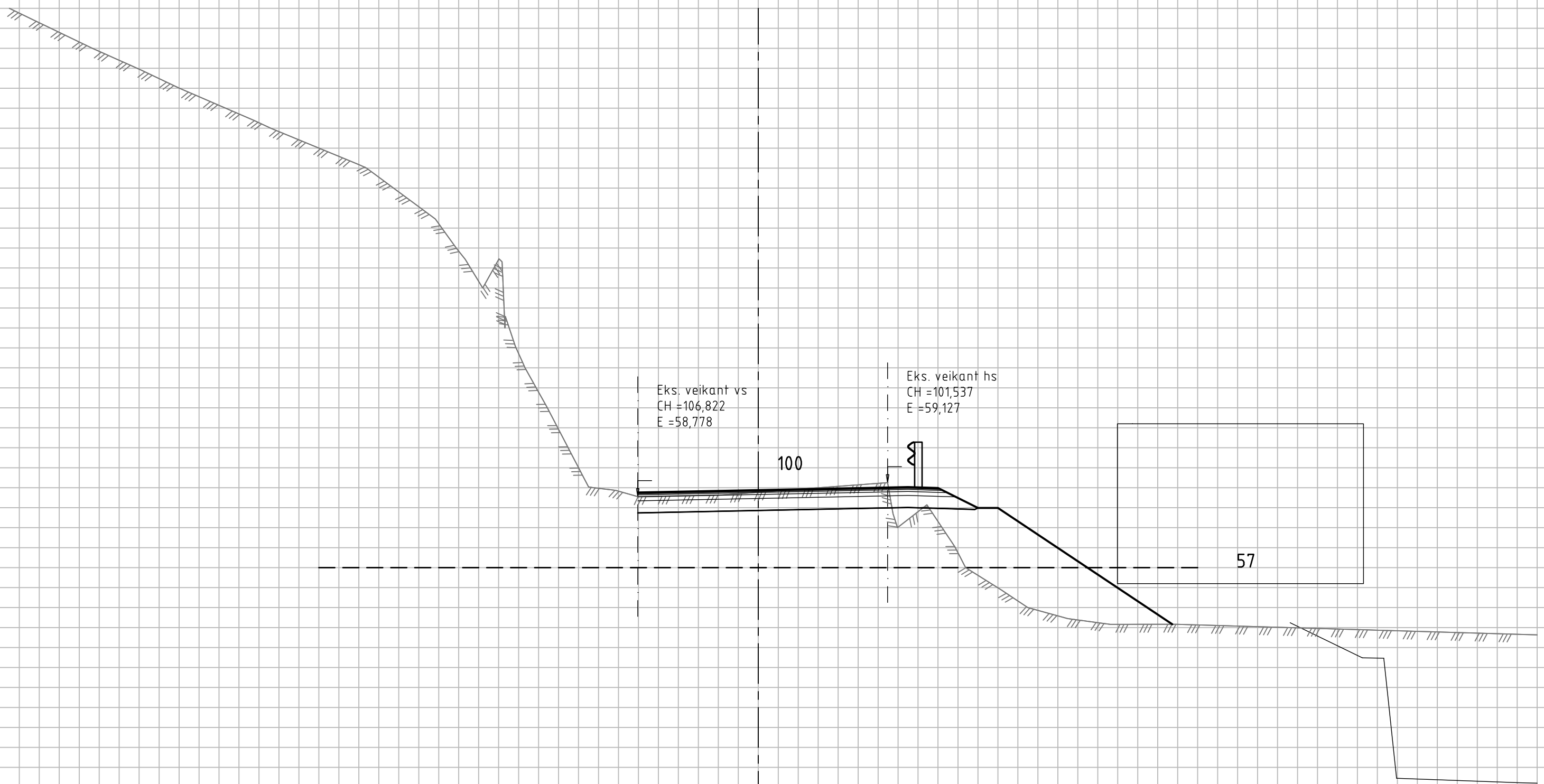

Status	Rev.	Endring	Utført	Kontr.	Ansv.	Dato
Arkitektgruppen Cubus AS			nomton	nourda	nokats	20.06.2024
Bjørnarhallen			Målestokk	1:100		Format A3
Vegmodell 60000			Oppdragsleder: Kathrine Lie Strandos			
Tverrprofiler			Oppdragsnr. 10222290			
Øvre Seimsmark			Disiplin:	Løpnummer:	Status	Rev:
SWECO 		Sweco Norge AS FANTOFTVEGEN 14P, 5072 BERGEN TLF.: 55 27 50 00 FAX.: 55 27 50 01	VEG	U011	X	00

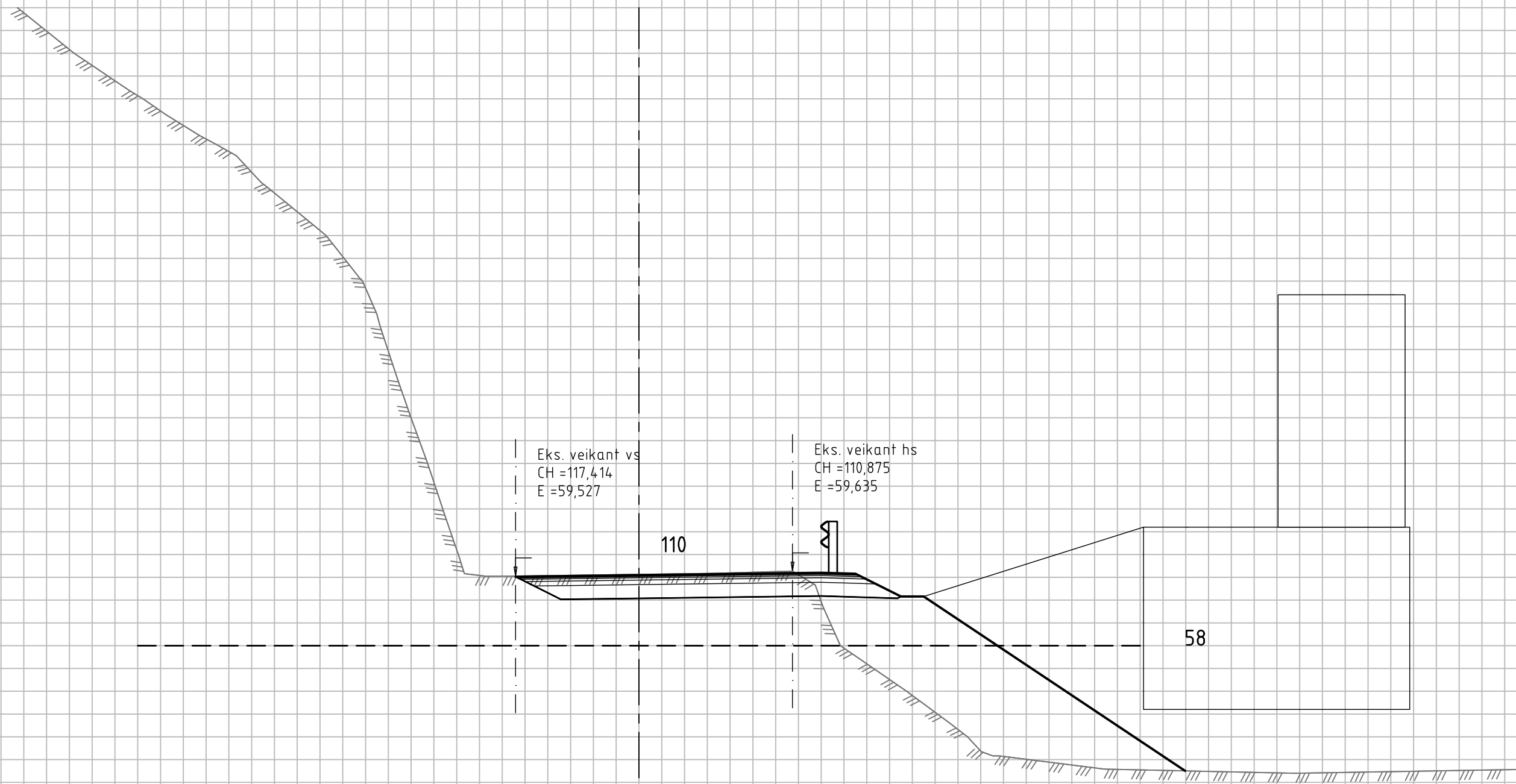

Status	Rev.	Endring	Utført	Kontr.	Ansv.	Dato
Arkitektgruppen Cubus AS			nomton	nourda	nokats	20.06.2024
Bjørnarhallen			Målestokk	1:100		Format A3
Vegmodell 60000			Oppdragsleder: Kathrine Lie Strandos			
Tverrprofiler			Oppdragsnr. 10222290			
Øvre Seimsmark			Disiplin:	Løpnummer:	Status	Rev:
SWECO 		Sweco Norge AS FANTOFVEGEN 14P, 5072 BERGEN TLF.: 55 27 50 00 FAX.: 55 27 50 01	VEG	U012	X	00

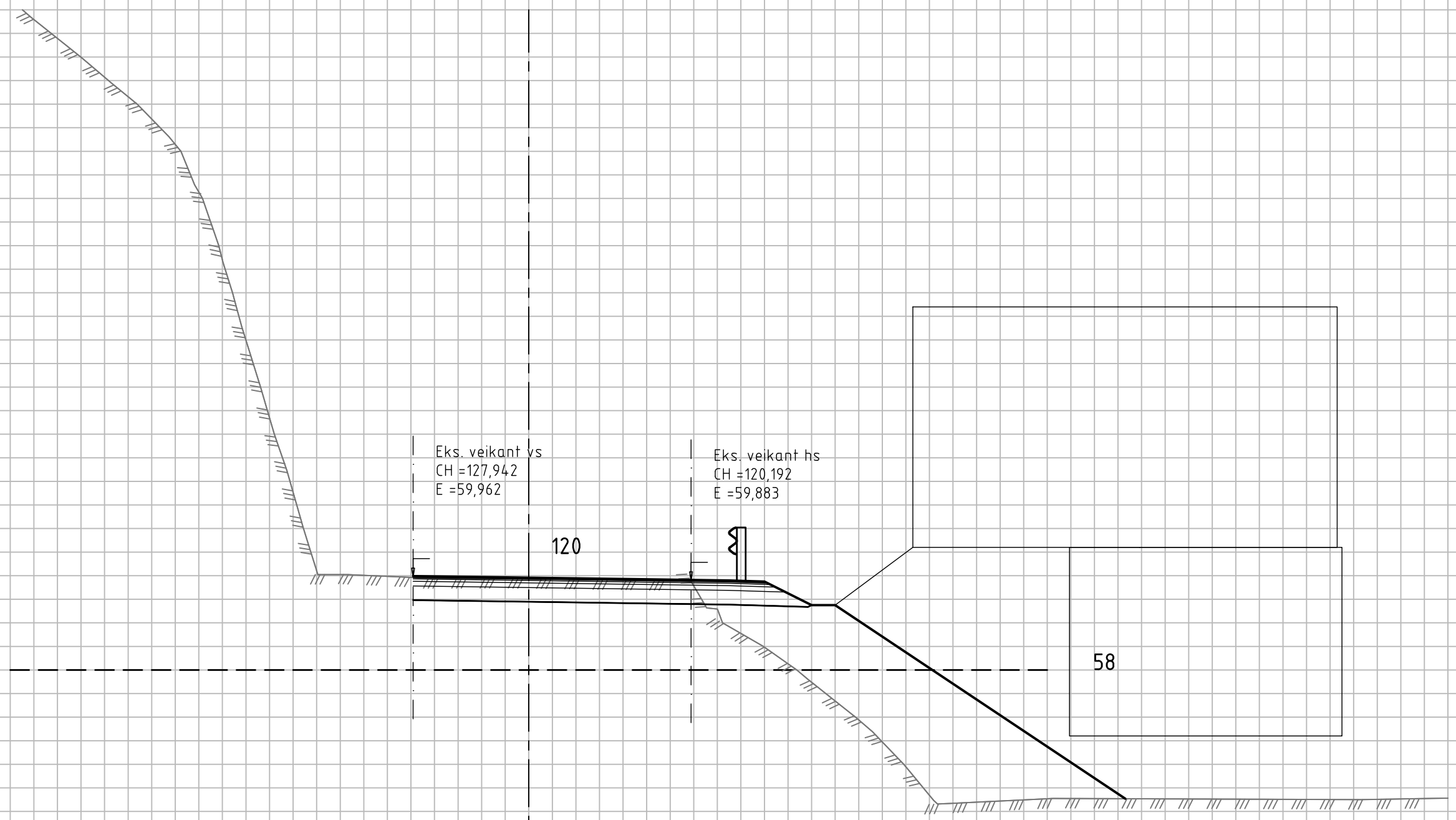

Status	Rev.	Endring	Utført	Kontr.	Ansv.	Dato
Arkitektgruppen Cubus AS			nomton	nourda	nokats	20.06.2024
Bjørnarhallen			Målestokk	1:100		Format A3
Vegmodell 60000			Oppdragsleder: Kathrine Lie Strandos			
Tverrprofiler			Oppdragsnr. 10222290			
Øvre Seimsmark			Disiplin:	Løpnummer:	Status	Rev:
SWECO 			VEG	U013	X	00
<small>Sweco Norge AS FANTOFTVEGEN 14P, 5072 BERGEN TLF.: 55 27 50 00 FAX.: 55 27 50 01</small>						

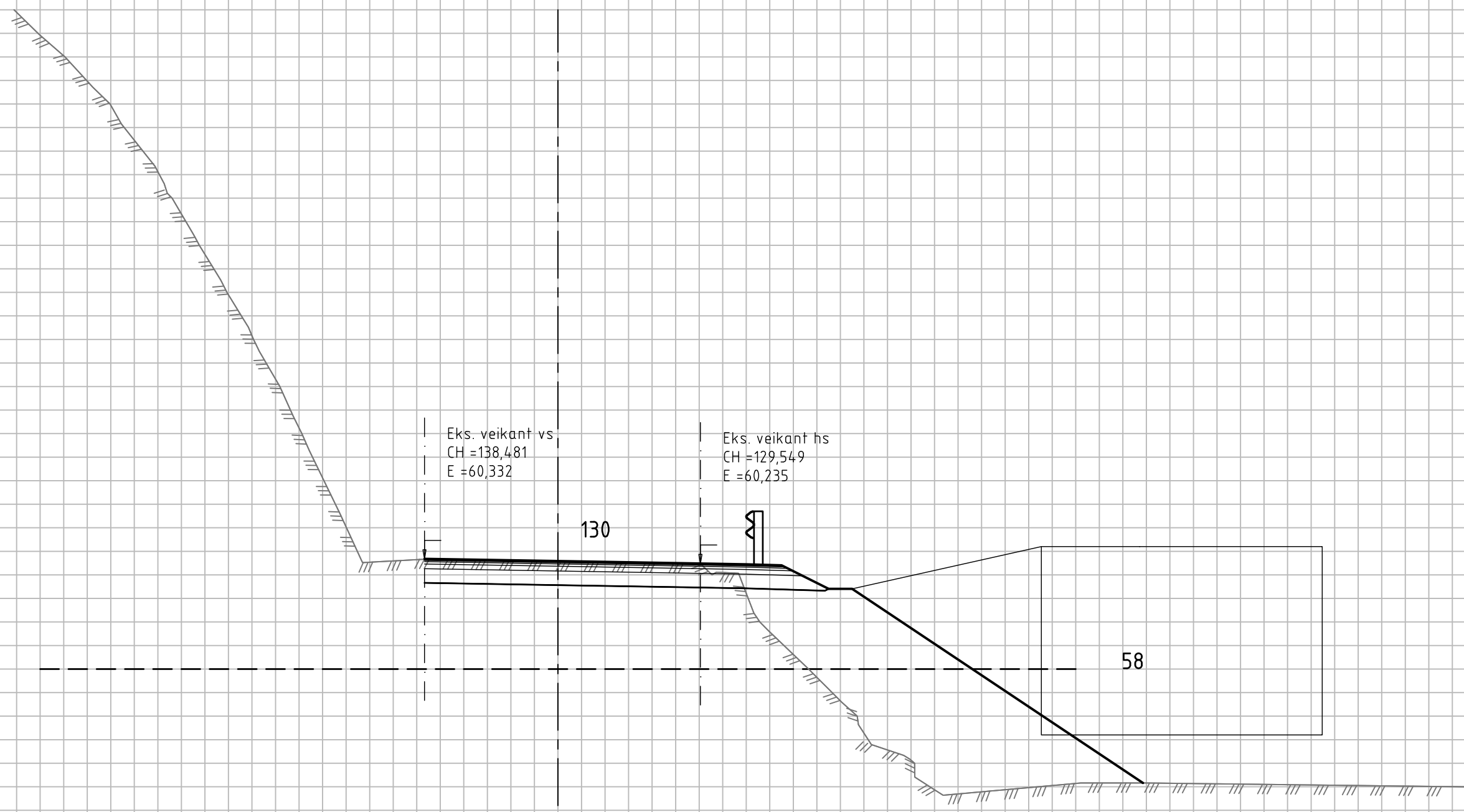

Status	Rev.	Endring	Utført	Kontr.	Ansv.	Dato
		Arkitektgruppen Cubus AS	nomton	nourda	nokats	20.06.2024
		Bjørnarhallen	Målestokk	1:100		Format A3
		Vegmodell 60000	Oppdragsleder: Kathrine Lie Strandos			
		Tverrprofiler	Oppdragsnr. 10222290			
		Øvre Seimsmark	Disiplin:	Løpnummer:	Status	Rev.
		SWECO 	VEG	U014	X	00
		<small>Sweco Norge AS FANTOFVEGEN 14P, 5072 BERGEN TLF.: 55 27 50 00 FAX.: 55 27 50 01</small>				

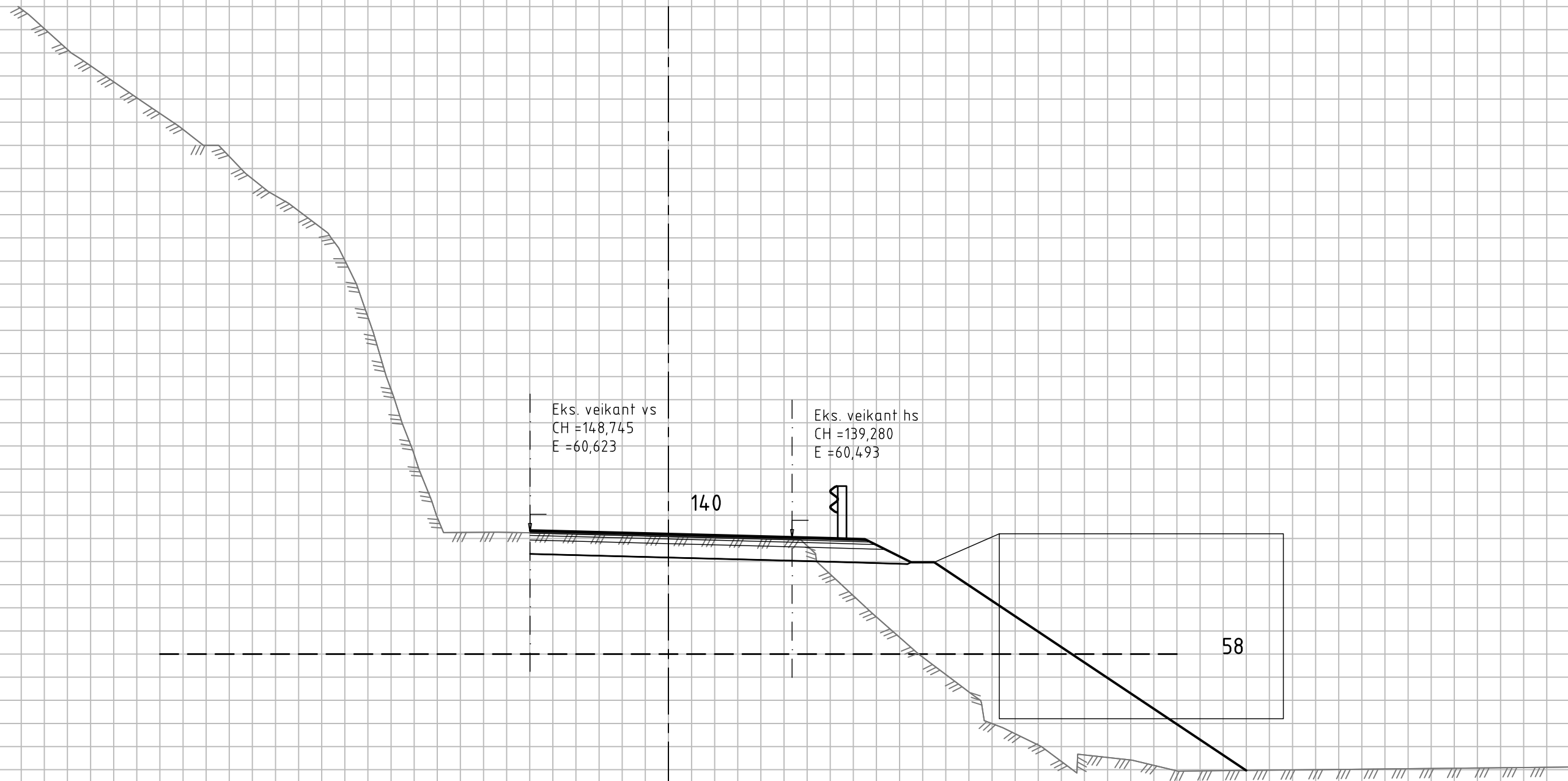

Status	Rev.	Endring	Utført	Kontr.	Ansv.	Dato
		Arkitektgruppen Cubus AS	nomton	nourda	nokats	20.06.2024
		Bjørnarhallen	Målestokk	1:100		Format A3
		Vegmodell 60000	Oppdragsleder: Kathrine Lie Strandos			
		Tverrprofiler	Oppdragsnr. 10222290			
		Øvre Seimsmark	Disiplin:	Løpnummer:	Status	Rev:
		SWECO 	VEG	U015	X	00
		<small>Sweco Norge AS FANTOFTVEGEN 14P, 5072 BERGEN TLF.: 55 27 50 00 FAX.: 55 27 50 01</small>				

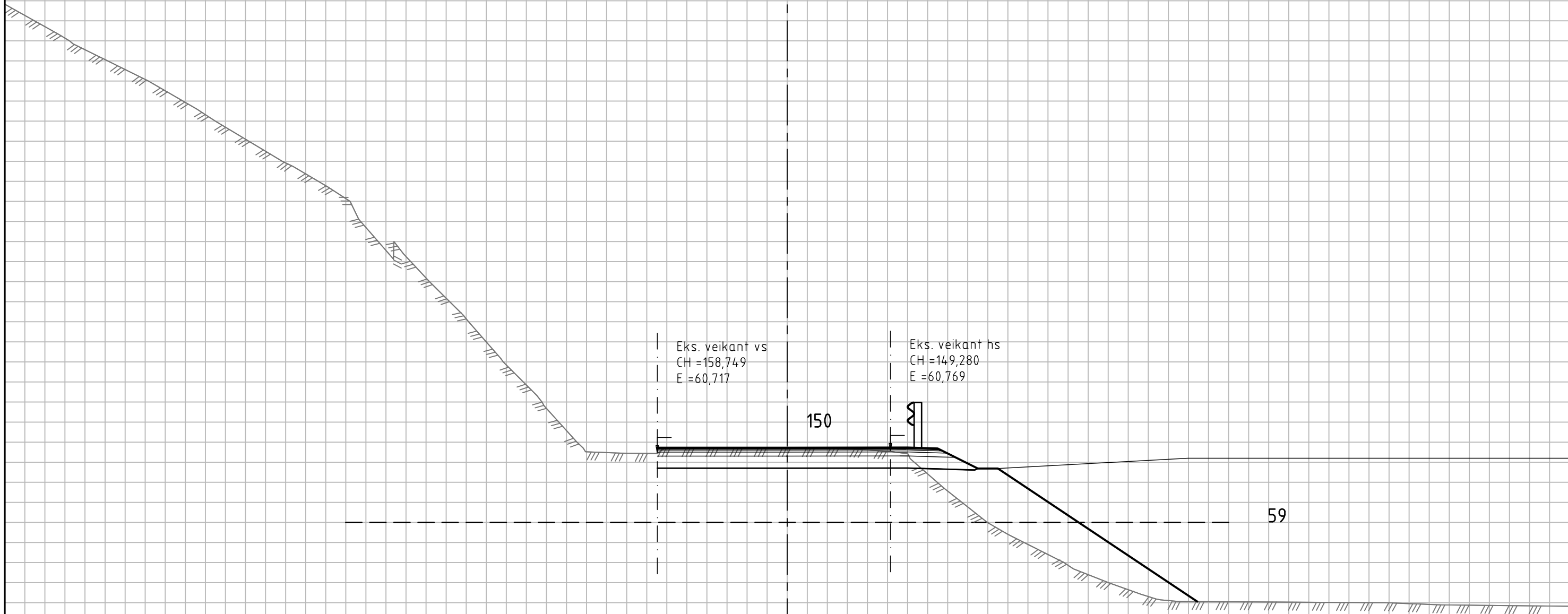

Status	Rev.	Endring	Utført	Kontr.	Ansv.	Dato
Arkitektgruppen Cubus AS			nomton	nourda	nokats	20.06.2024
Bjørnarhallen			Målestokk	1:100		Format A3
Vegmodell 60000			Oppdragsleder: Kathrine Lie Strandos			
Tverrprofiler			Oppdragsnr. 10222290			
Øvre Seimsmark			Disiplin:	Løpnummer:	Status	Rev.
SWECO 		Sweco Norge AS FANTOFVEGEN 14P, 5072 BERGEN TLF.: 55 27 50 00 FAX.: 55 27 50 01	VEG	U016	X	00

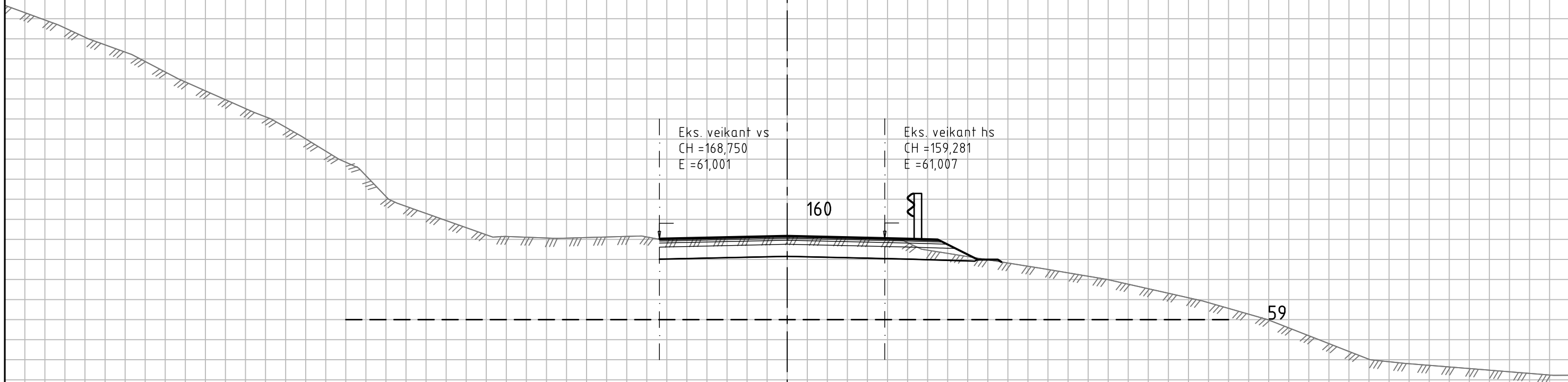

Status	Rev.	Endring	Utført	Kontr.	Ansv.	Dato
		Arkitektgruppen Cubus AS	nomton	nourda	nokats	20.06.2024
		Bjørnarhallen	Målestokk	1:100		Format A3
		Vegmodell 60000	Oppdragsleder: Kathrine Lie Strandos			
		Tverrprofiler	Oppdragsnr. 10222290			
		Øvre Seimsmark	Disiplin:	Løpnummer:	Status	Rev:
		SWECO 	VEG	U017	X	00
		<small>Sweco Norge AS FANTOFVEGEN 14P, 5072 BERGEN TLF.: 55 27 50 00 FAX.: 55 27 50 01</small>				

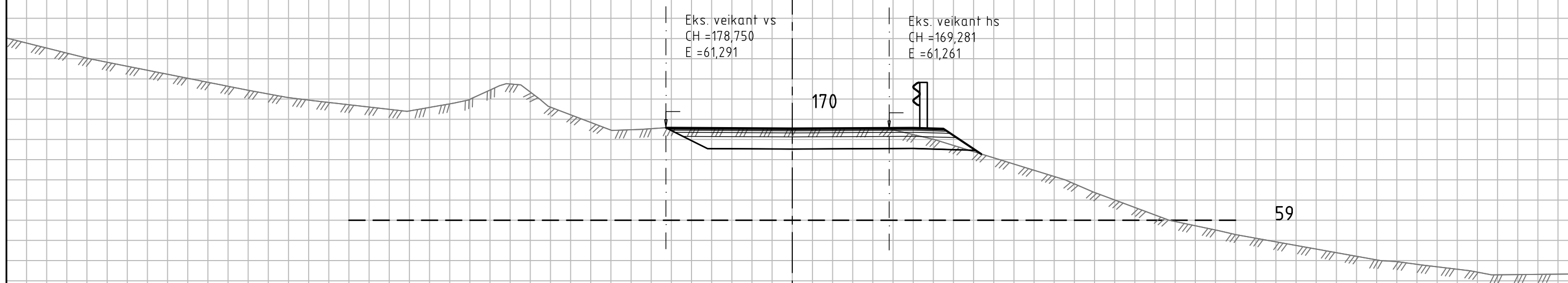

Status	Rev.	Endring	Utført	Kontr.	Ansv.	Dato
		Arkitektgruppen Cubus AS	nomton	nourda	nokats	20.06.2024
		Bjørnarhallen	Målestokk	1:100		Format A3
		Vegmodell 60000 Tverrprofiler Øvre Seimsmark	Oppdragsleder:	Kathrine Lie Strandos		
			Oppdragsnr.	10222290		
		SWECO 	Disiplin:	Løpnummer:	Status	Rev.
		Sweco Norge AS FANTOFTVEGEN 14P, 5072 BERGEN TLF.: 55 27 50 00 FAX.: 55 27 50 01	VEG	U018	X	00

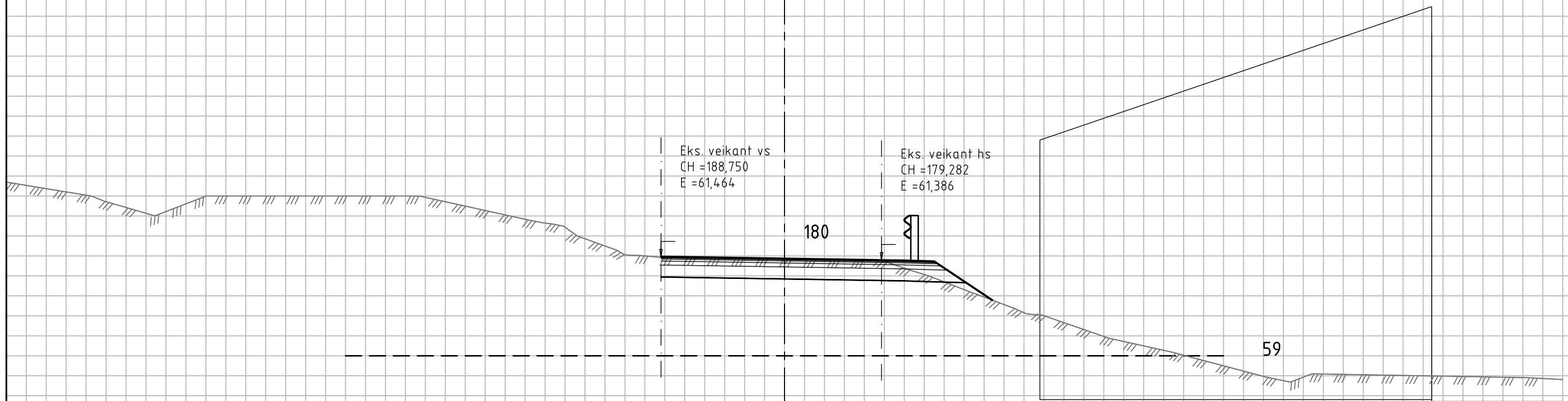

Status	Rev.	Endring	Utført	Kontr.	Ansv.	Dato
		Arkitektgruppen Cubus AS	nomton	nourda	nokats	20.06.2024
		Bjørnarhallen	Målestokk	1:100		Format A3
		Vegmodell 60000 Tverrprofiler Øvre Seimsmark	Oppdragsleder:	Kathrine Lie Strandos		
			Oppdragsnr.	10222290		
		SWECO 	Disiplin:	Løpnummer:	Status	Rev.
		Sweco Norge AS FANTOFTVEGEN 14P, 5072 BERGEN TLF.: 55 27 50 00 FAX.: 55 27 50 01	VEG	U019	X	00

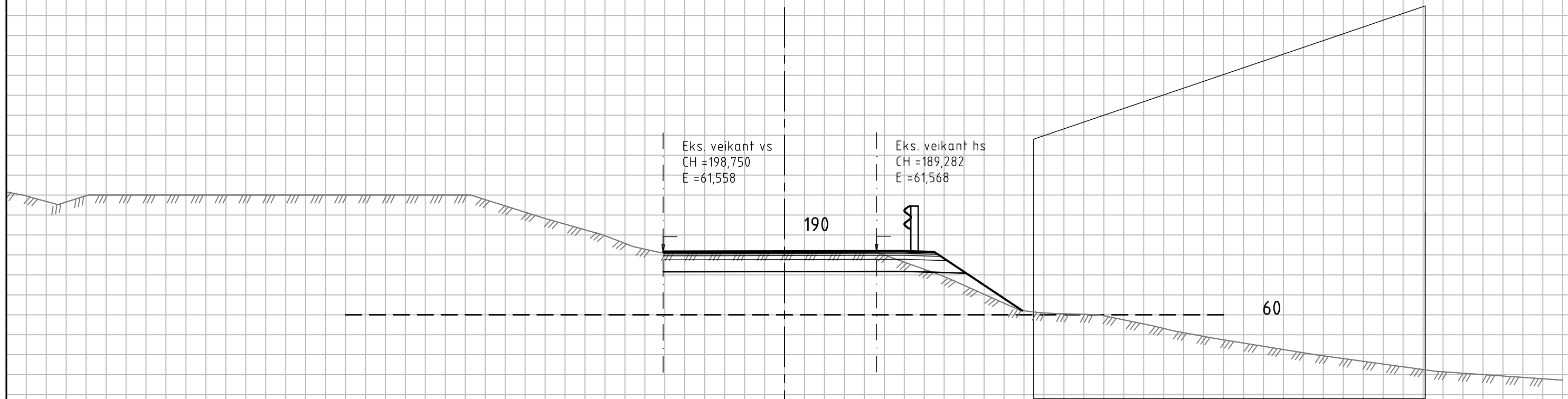

Status	Rev.	Endring	Utført	Kontr.	Ansv.	Dato
		Arkitektgruppen Cubus AS	nomton	nourda	nokats	20.06.2024
		Bjørnarhallen	Målestokk	1:100		Format A3
		Vegmodell 60000	Oppdragsleder: Kathrine Lie Strandos			
		Tverrprofiler	Oppdragsnr. 10222290			
		Øvre Seimsmark	Disiplin:	Løpnummer:	Status	Rev:
		SWECO 	VEG	U020	X	00
		<small>Sweco Norge AS FANTOFTVEGEN 14P, 5072 BERGEN TLF.: 55 27 50 00 FAX.: 55 27 50 01</small>				

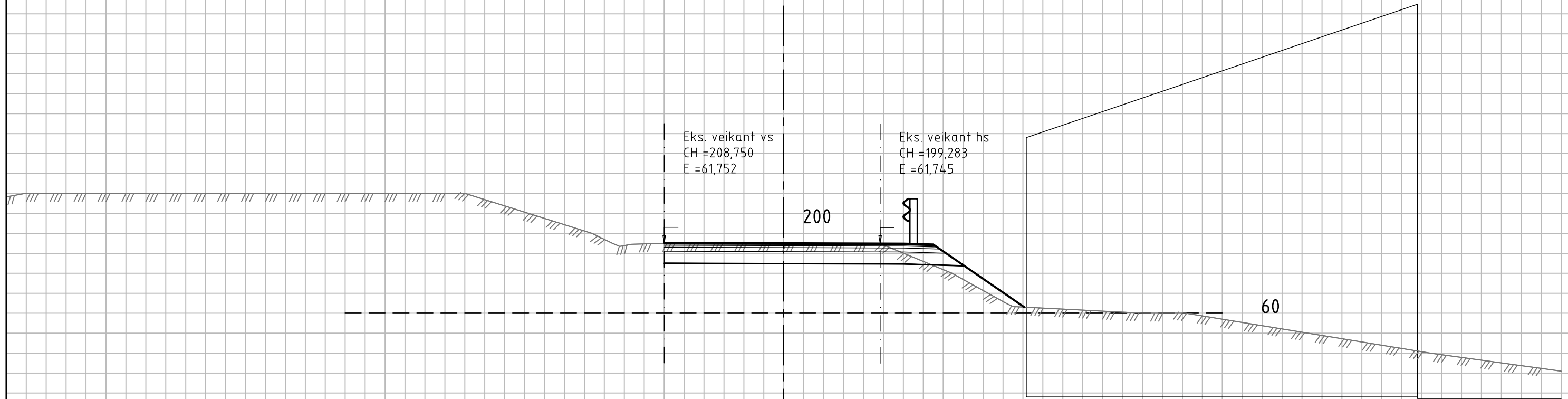

Status	Rev.	Endring	Utført	Kontr.	Ansv.	Dato
		Arkitektgruppen Cubus AS	nomton	nourda	nokats	20.06.2024
		Bjørnarhallen	Målestokk	1:100		Format A3
		Vegmodell 60000	Oppdragsleder: Kathrine Lie Strandos			
		Tverrprofiler	Oppdragsnr. 10222290			
		Øvre Seimsmark	Disiplin:	Løpnummer:	Status	Rev:
		SWECO 	VEG	U021	X	00
		<small>Sweco Norge AS FANTOFTVEGEN 14P, 5072 BERGEN TLF.: 55 27 50 00 FAX.: 55 27 50 01</small>				

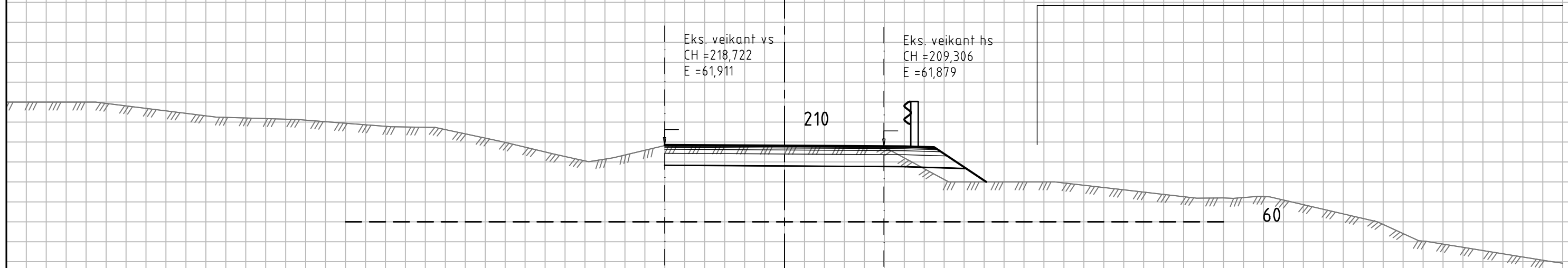

Status	Rev.	Endring	Utført	Kontr.	Ansv.	Dato
		Arkitektgruppen Cubus AS	nomton	nourda	nokats	20.06.2024
		Bjørnarhallen	Målestokk	1:100		Format A3
		Vegmodell 60000	Oppdragsleder: Kathrine Lie Strandos			
		Tverrprofiler	Oppdragsnr. 10222290			
		Øvre Seimsmark	Disiplin:	Løpnummer:	Status	Rev:
		SWECO 	VEG	U022	X	00
		<small>Sweco Norge AS FANTOFTVEGEN 14P, 5072 BERGEN TLF.: 55 27 50 00 FAX.: 55 27 50 01</small>				

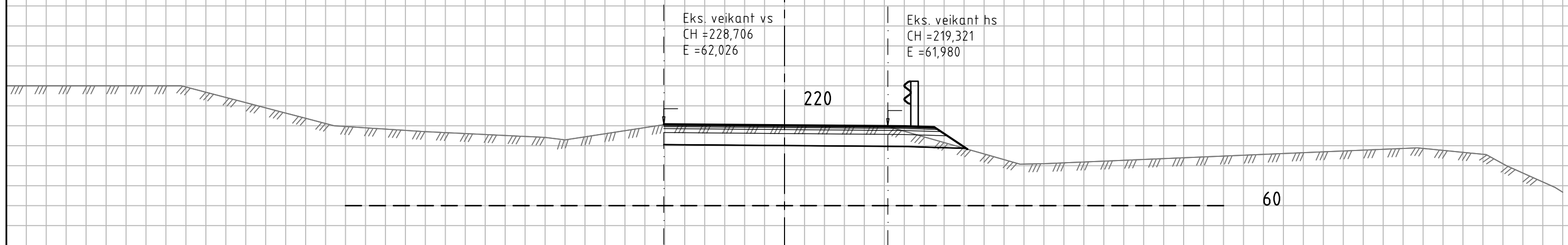

Status	Rev.	Endring	Utført	Kontr.	Ansv.	Dato
		Arkitektgruppen Cubus AS	nomton	nourda	nokats	20.06.2024
		Bjørnarhallen	Målestokk	1:100		Format A3
		Vegmodell 60000	Oppdragsleder: Kathrine Lie Strandos			
		Tverrprofiler	Oppdragsnr. 10222290			
		Øvre Seimsmark	Disiplin:	Løpenummer:	Status	Rev:
		SWECO 	VEG	U023	X	00
		<small>Sweco Norge AS FANTOFVEGEN 14P, 5072 BERGEN TLF.: 55 27 50 00 FAX.: 55 27 50 01</small>				

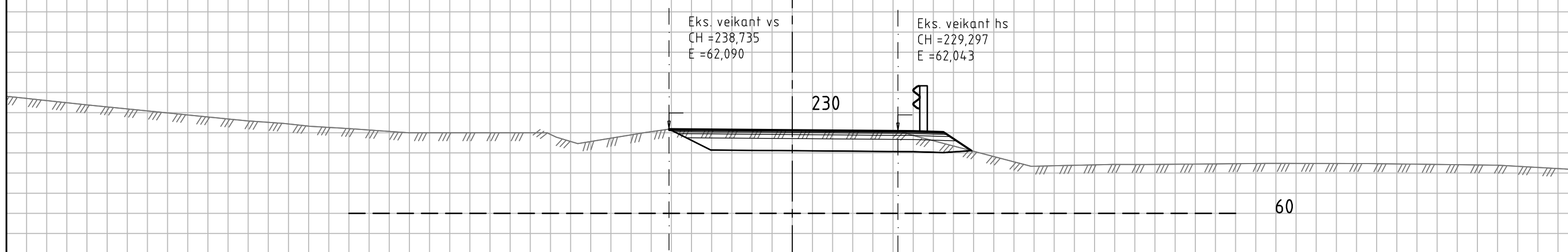

Status	Rev.	Endring	Utført	Kontr.	Ansv.	Dato
		Arkitektgruppen Cubus AS	nomton	nourda	nokats	20.06.2024
		Bjørnarhallen	Målestokk	1:100		Format A3
		Vegmodell 60000	Oppdragsleder: Kathrine Lie Strandos			
		Tverrprofiler	Oppdragsnr. 10222290			
		Øvre Seimsmark	Disiplin:	Løpnummer:	Status	Rev:
		SWECO 	VEG	U024	X	00
		<small>Sweco Norge AS FANTOFVEGEN 14P, 5072 BERGEN TLF.: 55 27 50 00 FAX.: 55 27 50 01</small>				

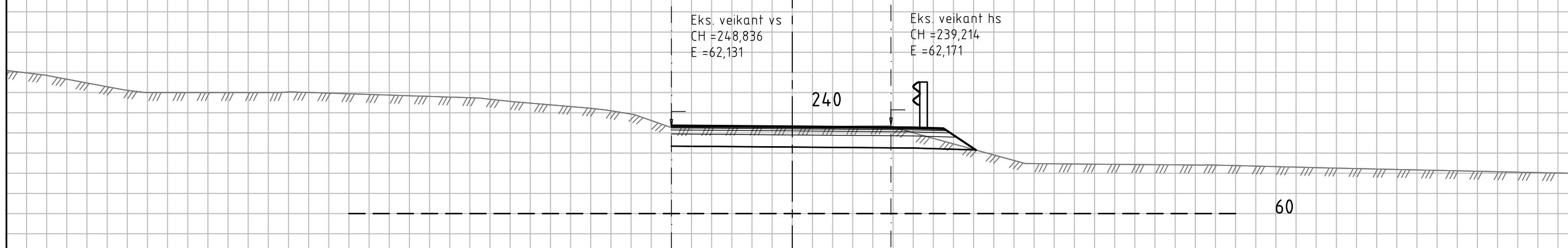

Status	Rev.	Endring	Utført	Kontr.	Ansv.	Dato
		Arkitektgruppen Cubus AS	nomton	nourda	nokats	20.06.2024
		Bjørnarhallen	Målestokk	1:100		Format A3
		Vegmodell 60000	Oppdragsleder: Kathrine Lie Strandos			
		Tverrprofiler	Oppdragsnr. 10222290			
		Øvre Seimsmark	Disiplin:	Løpnummer:	Status	Rev:
		SWECO 	VEG	U025	X	00
		<small>Sweco Norge AS FANTOFTVEGEN 14P, 5072 BERGEN TLF.: 55 27 50 00 FAX.: 55 27 50 01</small>				

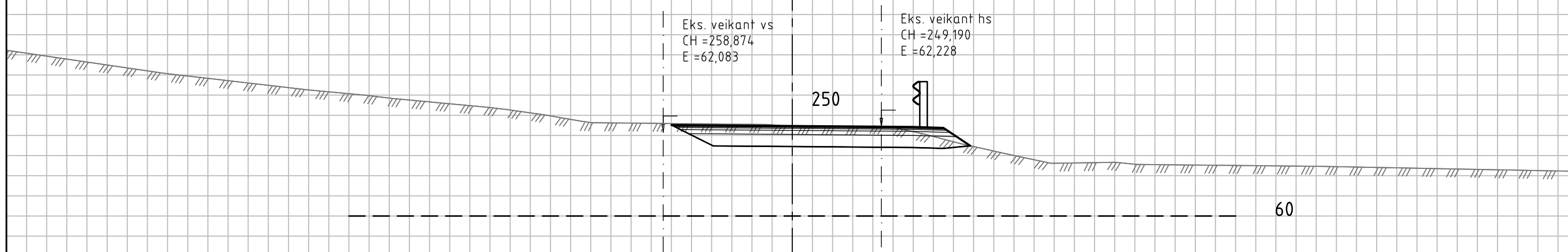

Status	Rev.	Endring	Utført	Kontr.	Ansv.	Dato
		Arkitektgruppen Cubus AS	nomton	nourda	nokats	20.06.2024
		Bjørnarhallen	Målestokk	1:100		Format A3
		Vegmodell 60000	Oppdragsleder: Kathrine Lie Strandos			
		Tverrprofiler	Oppdragsnr. 10222290			
		Øvre Seimsmark	Disiplin:	Løpnummer:	Status	Rev:
		SWECO 	VEG	U026	X	00
		<small>Sweco Norge AS FANTOFTVEGEN 14P, 5072 BERGEN TLF.: 55 27 50 00 FAX.: 55 27 50 01</small>				

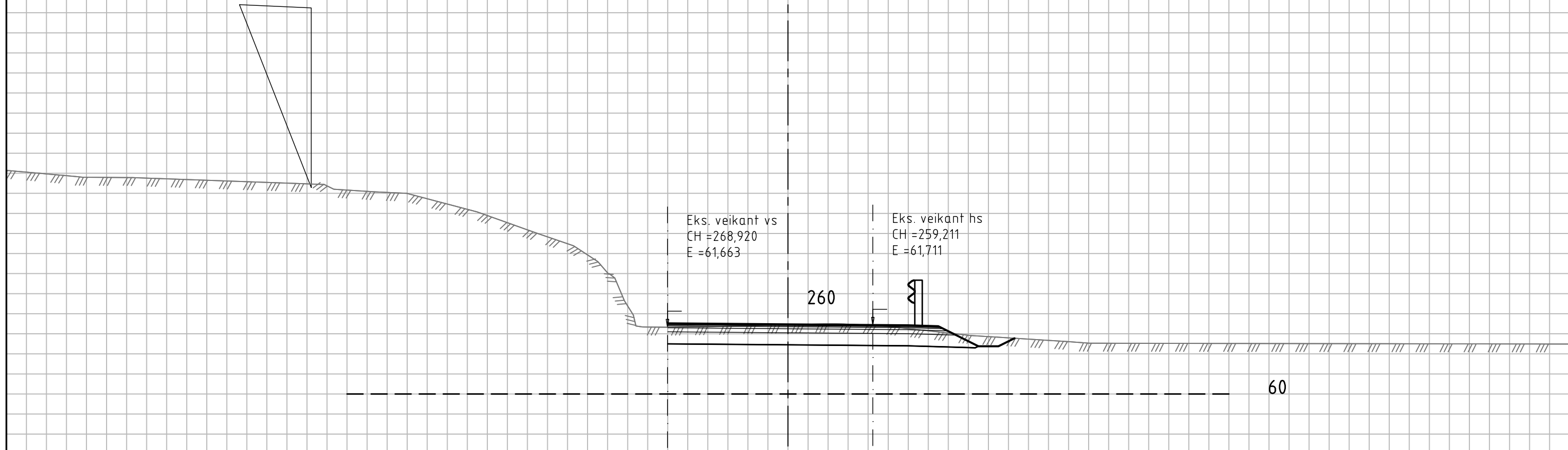

Status	Rev.	Endring	Utført	Kontr.	Ansv.	Dato
		Arkitektgruppen Cubus AS	nomton	nourda	nokats	20.06.2024
		Bjørnarhallen	Målestokk	1:100		Format A3
		Vegmodell 60000	Oppdragsleder: Kathrine Lie Strandos			
		Tverrprofiler	Oppdragsnr. 10222290			
		Øvre Seimsmark	Disiplin:	Løpnummer:	Status	Rev:
		SWECO 	VEG	U027	X	00
		<small>Sweco Norge AS FANTOFTVEGEN 14P, 5072 BERGEN TLF.: 55 27 50 00 FAX.: 55 27 50 01</small>				

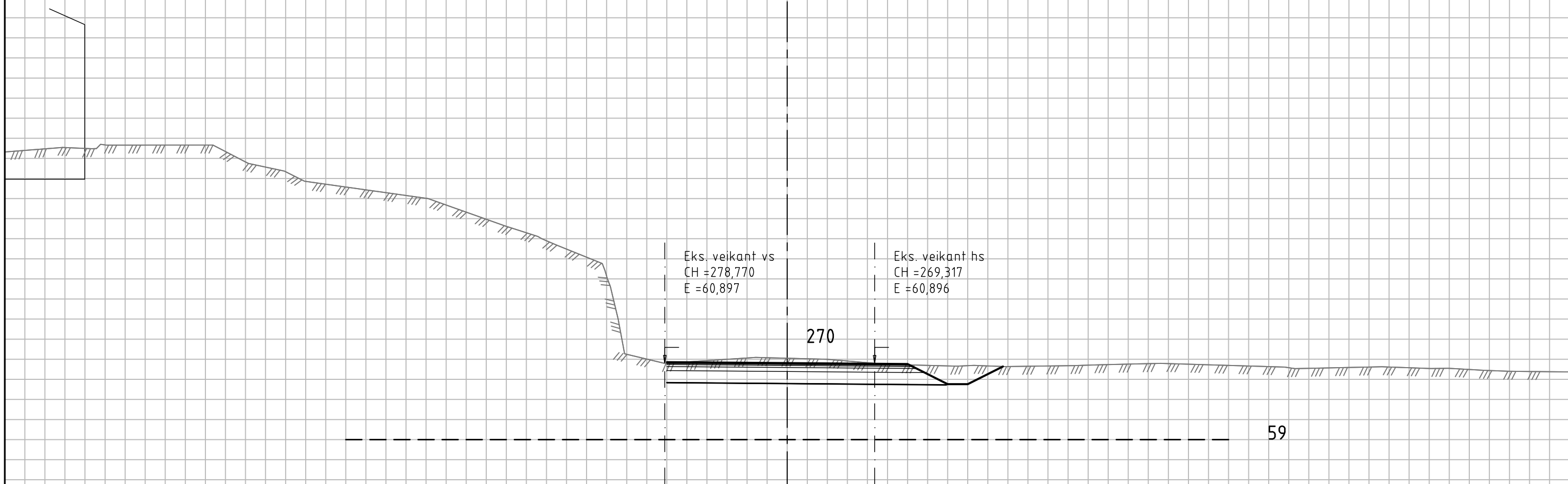

Status	Rev.	Endring	Utført	Kontr.	Ansv.	Dato
		Arkitektgruppen Cubus AS	nomton	nourda	nokats	20.06.2024
		Bjørnarhallen	Målestokk	1:100		Format A3
		Vegmodell 60000	Oppdragsleder: Kathrine Lie Strandos			
		Tverrprofiler	Oppdragsnr. 10222290			
		Øvre Seimsmark	Disiplin:	Løpnummer:	Status	Rev:
		SWECO 	VEG	U028	X	00
		Sweco Norge AS FANTOFVEGEN 14P, 5072 BERGEN TLF.: 55 27 50 00 FAX.: 55 27 50 01				

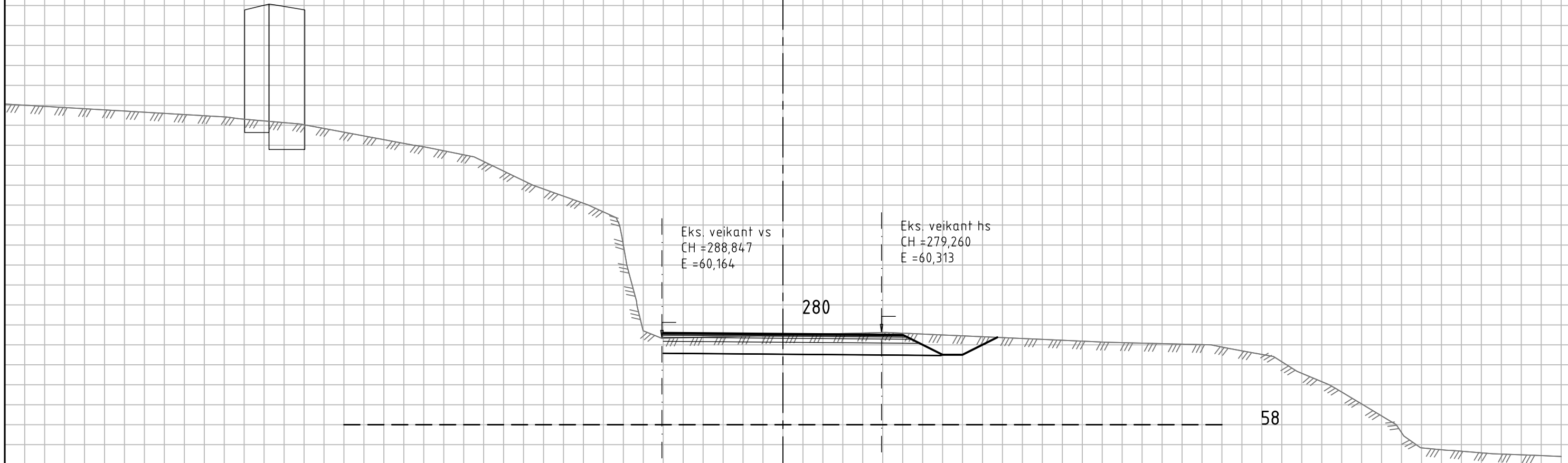

Status	Rev.	Endring	Utført	Kontr.	Ansv.	Dato
		Arkitektgruppen Cubus AS	nomton	nourda	nokats	20.06.2024
		Bjørnarhallen	Målestokk	1:100		Format A3
		Vegmodell 60000	Oppdragsleder: Kathrine Lie Strandos			
		Tverrprofiler	Oppdragsnr. 10222290			
		Øvre Seimsmark	Disiplin:	Løpnummer:	Status	Rev:
		SWECO 	VEG	U029	X	00
		Sweco Norge AS FANTOFTVEGEN 14P, 5072 BERGEN TLF.: 55 27 50 00 FAX.: 55 27 50 01				

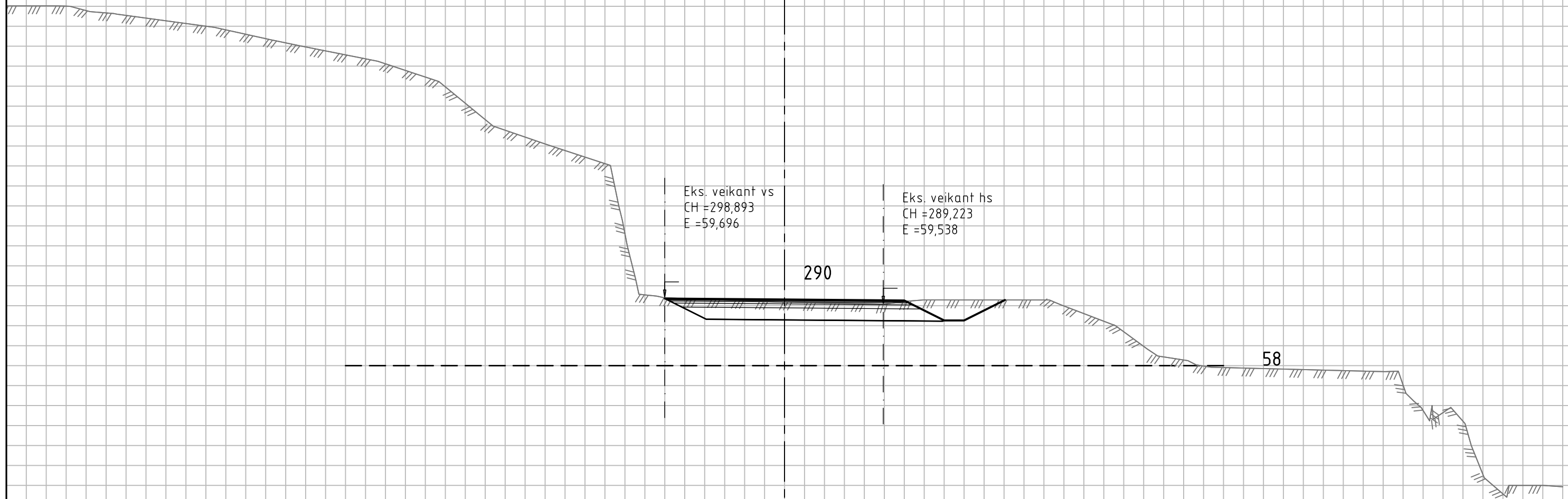

Status	Rev.	Endring	Utført	Kontr.	Ansv.	Dato
		Arkitektgruppen Cubus AS	nomton	nourda	nokats	20.06.2024
		Bjørnarhallen	Målestokk	1:100		Format A3
		Vegmodell 60000	Oppdragsleder: Kathrine Lie Strandos			
		Tverrprofiler	Oppdragsnr. 10222290			
		Øvre Seimsmark	Disiplin:	Løpnummer:	Status	Rev:
		SWECO 	VEG	U030	X	00
		<small>Sweco Norge AS FANTOFVEGEN 14P, 5072 BERGEN TLF.: 55 27 50 00 FAX.: 55 27 50 01</small>				

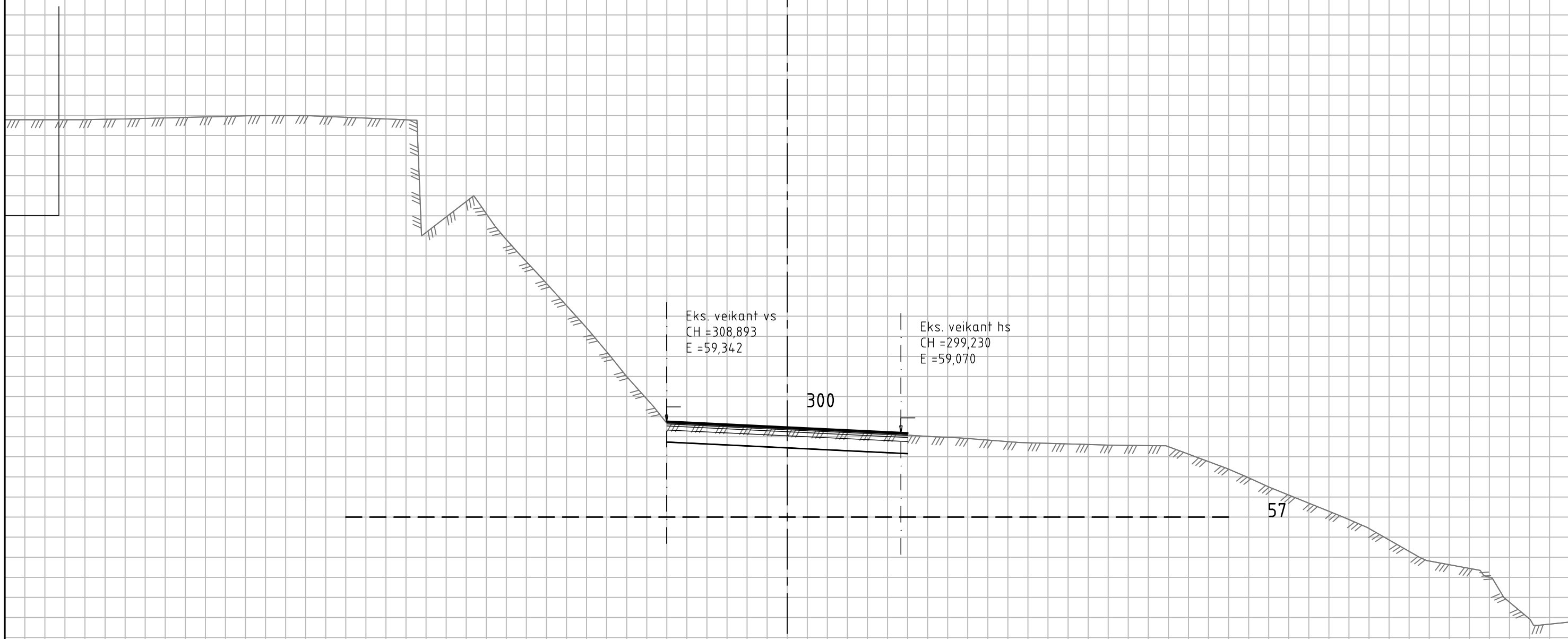

Status	Rev.	Endring	Utført	Kontr.	Ansv.	Dato
		Arkitektgruppen Cubus AS	nomton	nourda	nokats	20.06.2024
		Bjørnarhallen	Målestokk	1:100		Format A3
		Vegmodell 60000	Oppdragsleder: Kathrine Lie Strandos			
		Tverrprofiler	Oppdragsnr. 10222290			
		Øvre Seimsmark	Disiplin:	Løpnummer:	Status	Rev:
		SWECO 	VEG	U031	X	00
		Sweco Norge AS FANTOFTVEGEN 14P, 5072 BERGEN TLF.: 55 27 50 00 FAX.: 55 27 50 01				

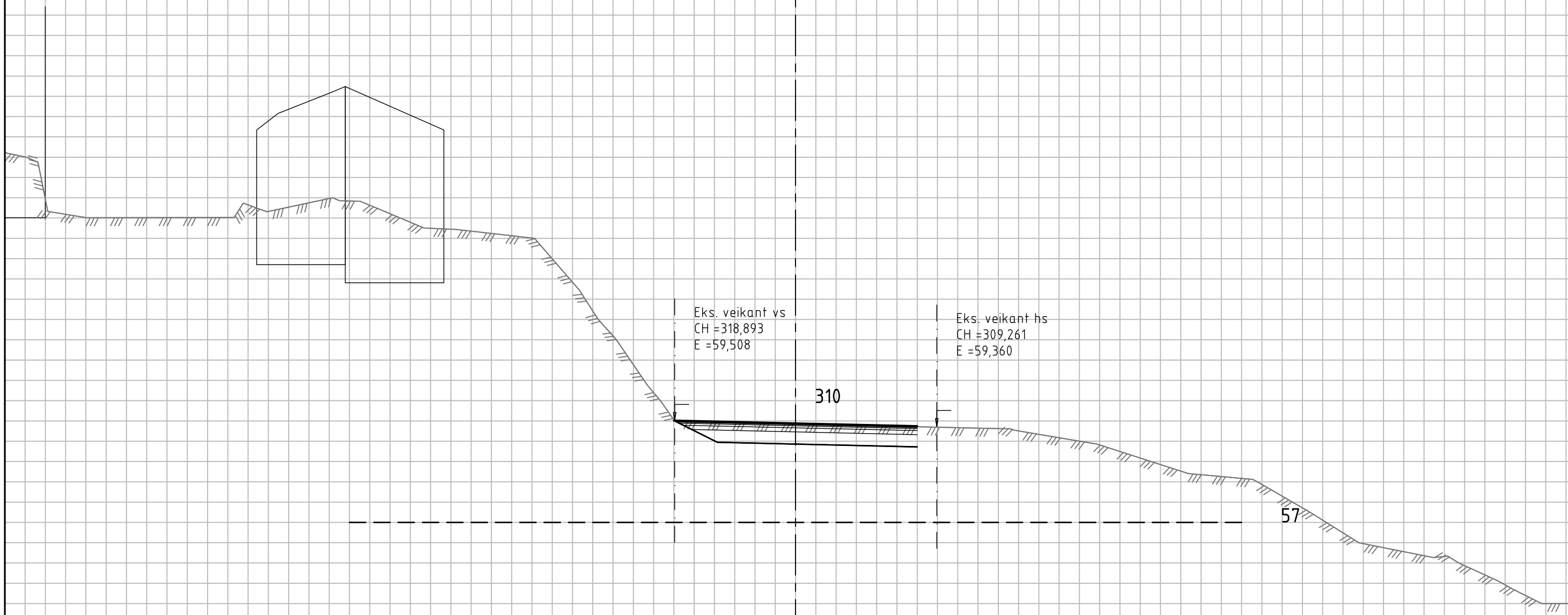

Status	Rev.	Endring	Utført	Kontr.	Ansv.	Dato
		Arkitektgruppen Cubus AS	nomton	nourda	nokats	20.06.2024
		Bjørnarhallen	Målestokk	1:100		Format A3
		Vegmodell 60000	Oppdragsleder: Kathrine Lie Strandos			
		Tverrprofiler	Oppdragsnr. 10222290			
		Øvre Seimsmark	Disiplin:	Løpnummer:	Status	Rev:
		SWECO 	VEG	U032	X	00
		<small>Sweco Norge AS FANTOFTVEGEN 14P, 5072 BERGEN TLF.: 55 27 50 00 FAX.: 55 27 50 01</small>				

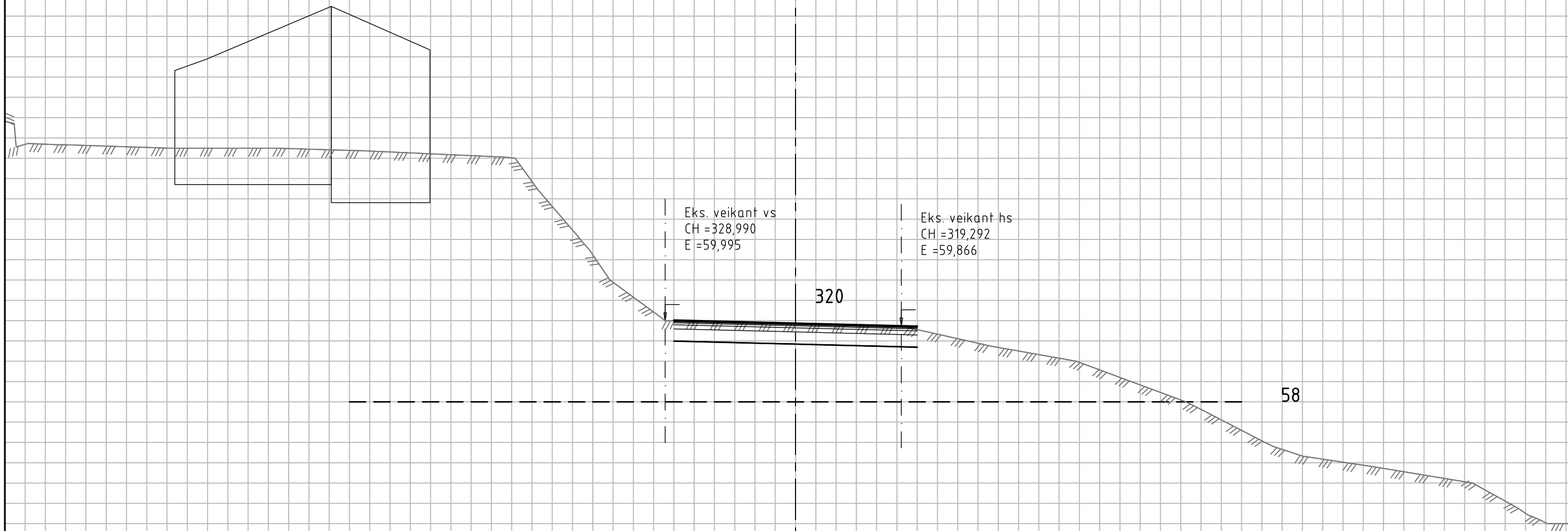

Status	Rev.	Endring	Utført	Kontr.	Ansv.	Dato
		Arkitektgruppen Cubus AS	nomton	nourda	nokats	20.06.2024
		Bjørnarhallen	Målestokk	1:100		Format A3
		Vegmodell 60000 Tverrprofiler Øvre Seimsmark	Oppdragsleder:	Kathrine Lie Strandos		
			Oppdragsnr.	10222290		
		SWECO 	Disiplin:	Løpnummer:	Status	Rev.
		Sweco Norge AS FANTOFVEGEN 14P, 5072 BERGEN TLF.: 55 27 50 00 FAX.: 55 27 50 01	VEG	U033	X	00

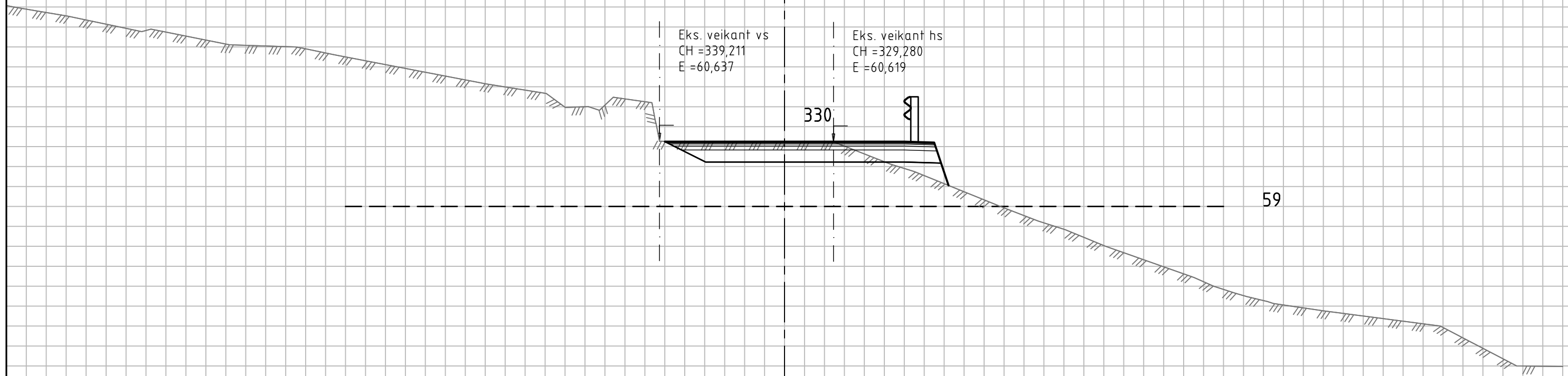

Status	Rev.	Endring	Utført	Kontr.	Ansv.	Dato
		Arkitektgruppen Cubus AS	nomton	nourda	nokats	20.06.2024
		Bjørnarhallen	Målestokk	1:100		Format A3
		Vegmodell 60000 Tverrprofiler Øvre Seimsmark	Oppdragsleder:	Kathrine Lie Strandos		
			Oppdragsnr.	10222290		
		Disiplin:	Løpenummer:	Status:	Rev:	
<small>Sweco Norge AS FANTOFTVEGEN 14P, 5072 BERGEN TLF.: 55 27 50 00 FAX.: 55 27 50 01</small>		VEG	U034	X	00	

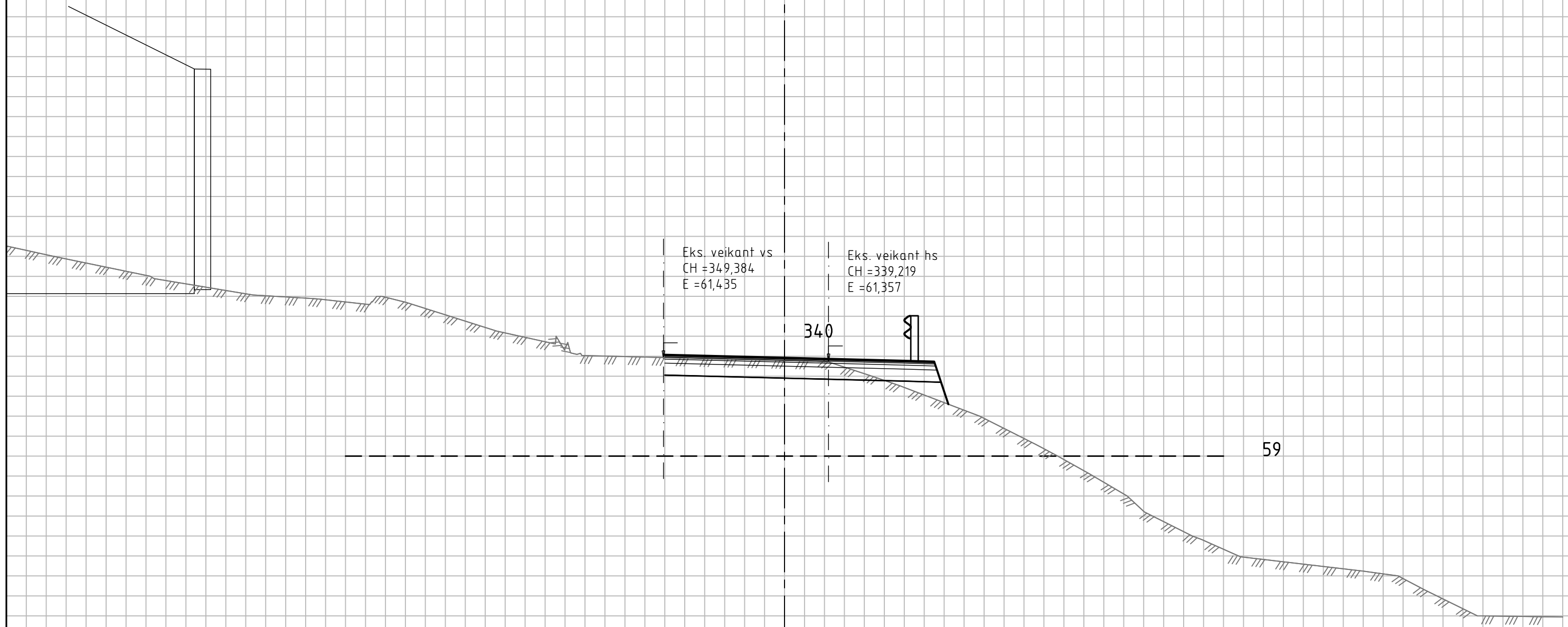

Status	Rev.	Endring	Utført	Kontr.	Ansv.	Dato
		Arkitektgruppen Cubus AS	nomton	nourda	nokats	20.06.2024
		Bjørnarhallen	Målestokk	1:100		Format A3
		Vegmodell 60000 Tverrprofiler Øvre Seimsmark	Oppdragsleder:	Kathrine Lie Strandos		
			Oppdragsnr.	10222290		
		SWECO 	Disiplin:	Løpenummer:	Status	Rev:
		Sweco Norge AS FANTOFTVEGEN 14P, 5072 BERGEN TLF.: 55 27 50 00 FAX.: 55 27 50 01	VEG	U035	X	00

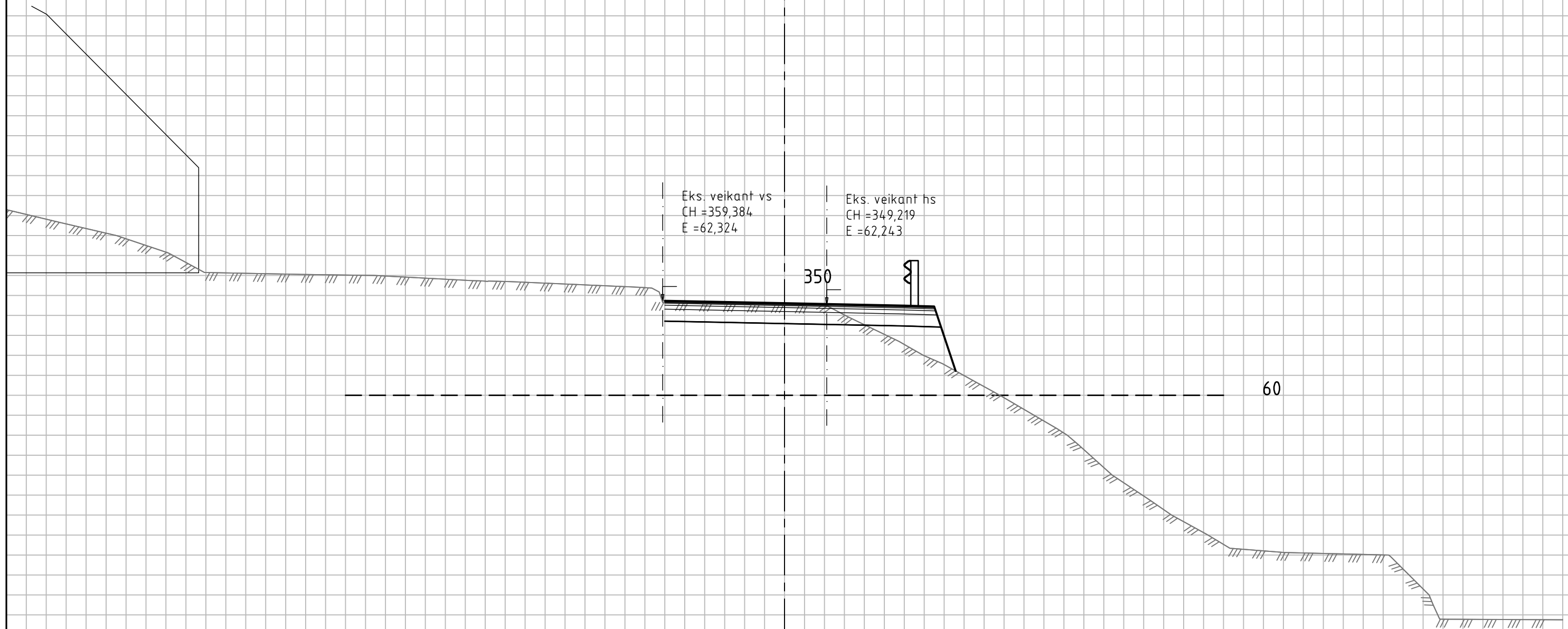

Status	Rev.	Endring	Utført	Kontr.	Ansv.	Dato
		Arkitektgruppen Cubus AS	nomton	nourda	nokats	20.06.2024
		Bjørnarhallen	Målestokk	1:100		Format A3
		Vegmodell 60000 Tverrprofiler Øvre Seimsmark	Oppdragsleder:	Kathrine Lie Strandos		
			Oppdragsnr.	10222290		
		SWECO 	Disiplin:	Løpnummer:	Status	Rev.
		Sweco Norge AS FANTOFTVEGEN 14P, 5072 BERGEN TLF.: 55 27 50 00 FAX.: 55 27 50 01	VEG	U036	X	00

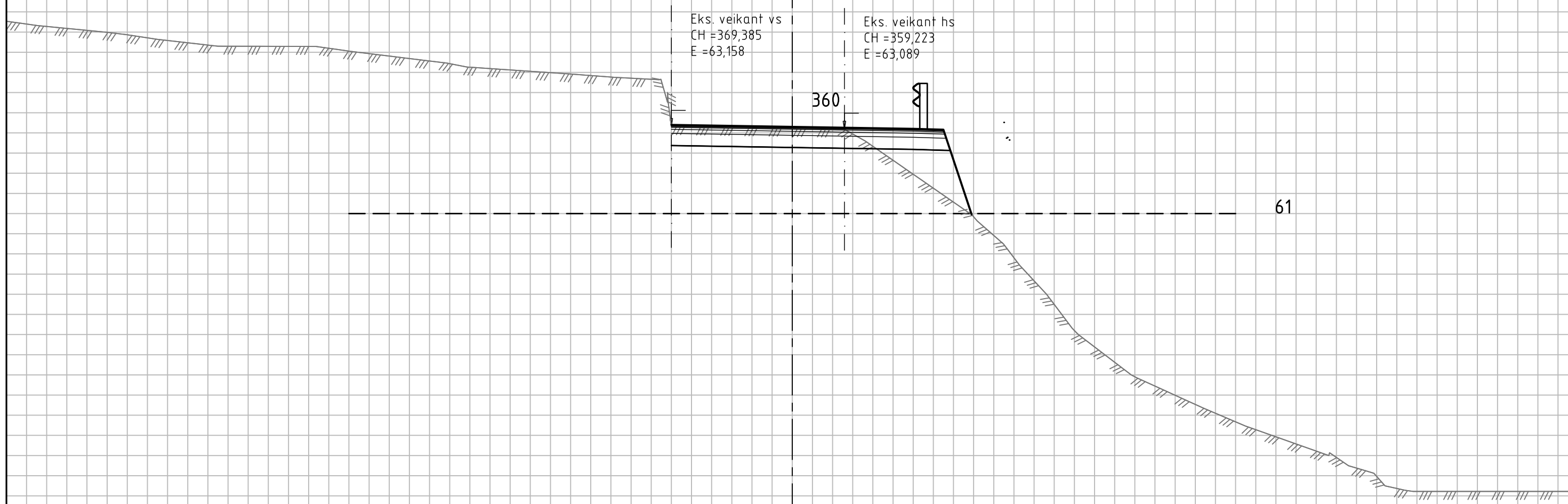

Status	Rev.	Endring	Utført	Kontr.	Ansv.	Dato
		Arkitektgruppen Cubus AS	nomton	nourda	nokats	20.06.2024
		Bjørnarhallen	Målestokk	1:100		Format A3
		Vegmodell 60000	Oppdragsleder: Kathrine Lie Strandos			
		Tverrprofiler	Oppdragsnr. 10222290			
		Øvre Seimsmark	Disiplin:	Løpnummer:	Status	Rev:
		SWECO 	VEG	U037	X	00
		Sweco Norge AS FANTOFVÆGEN 14P, 5072 BERGEN TLF.: 55 27 50 00 FAX.: 55 27 50 01				

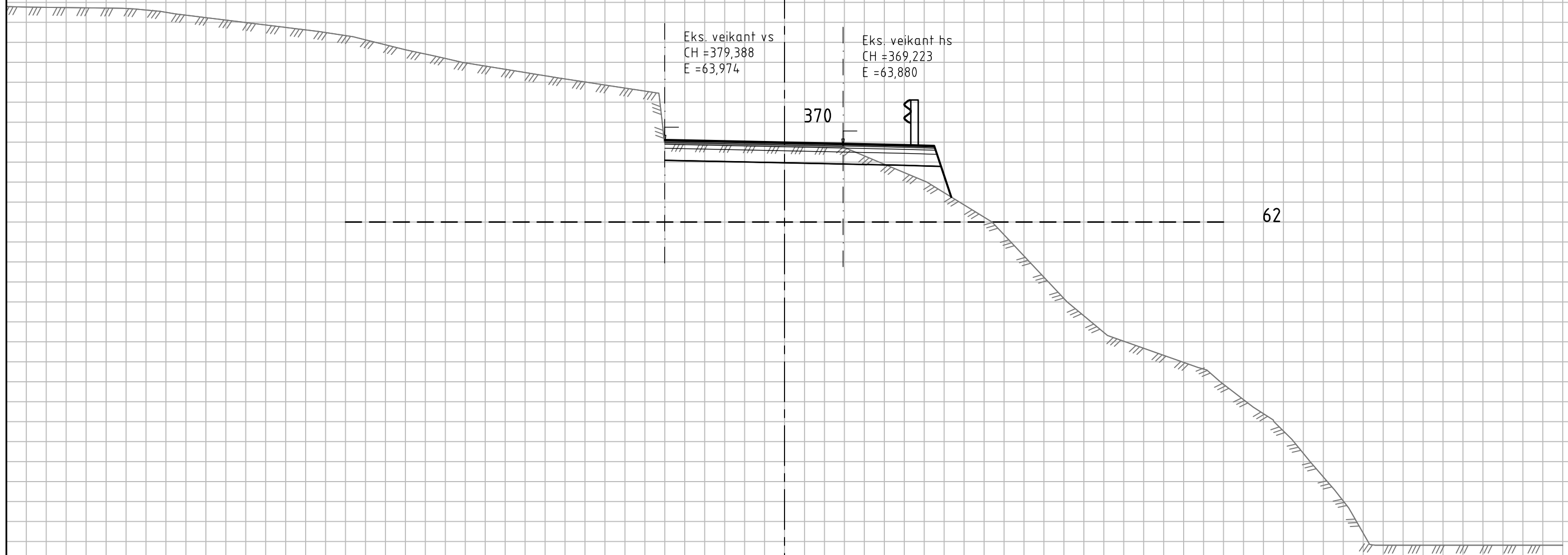

Status	Rev.	Endring	Utført	Kontr.	Ansv.	Dato
		Arkitektgruppen Cubus AS	nomton	nourda	nokats	20.06.2024
		Bjørnarhallen	Målestokk	1:100		Format A3
		Vegmodell 60000	Oppdragsleder: Kathrine Lie Strandos			
		Tverrprofiler	Oppdragsnr. 10222290			
		Øvre Seimsmark	Disiplin:	Løpnummer:	Status	Rev:
		SWECO 	VEG	U038	X	00
		<small>Sweco Norge AS FANTOFTVEGEN 14P, 5072 BERGEN TLF.: 55 27 50 00 FAX.: 55 27 50 01</small>				

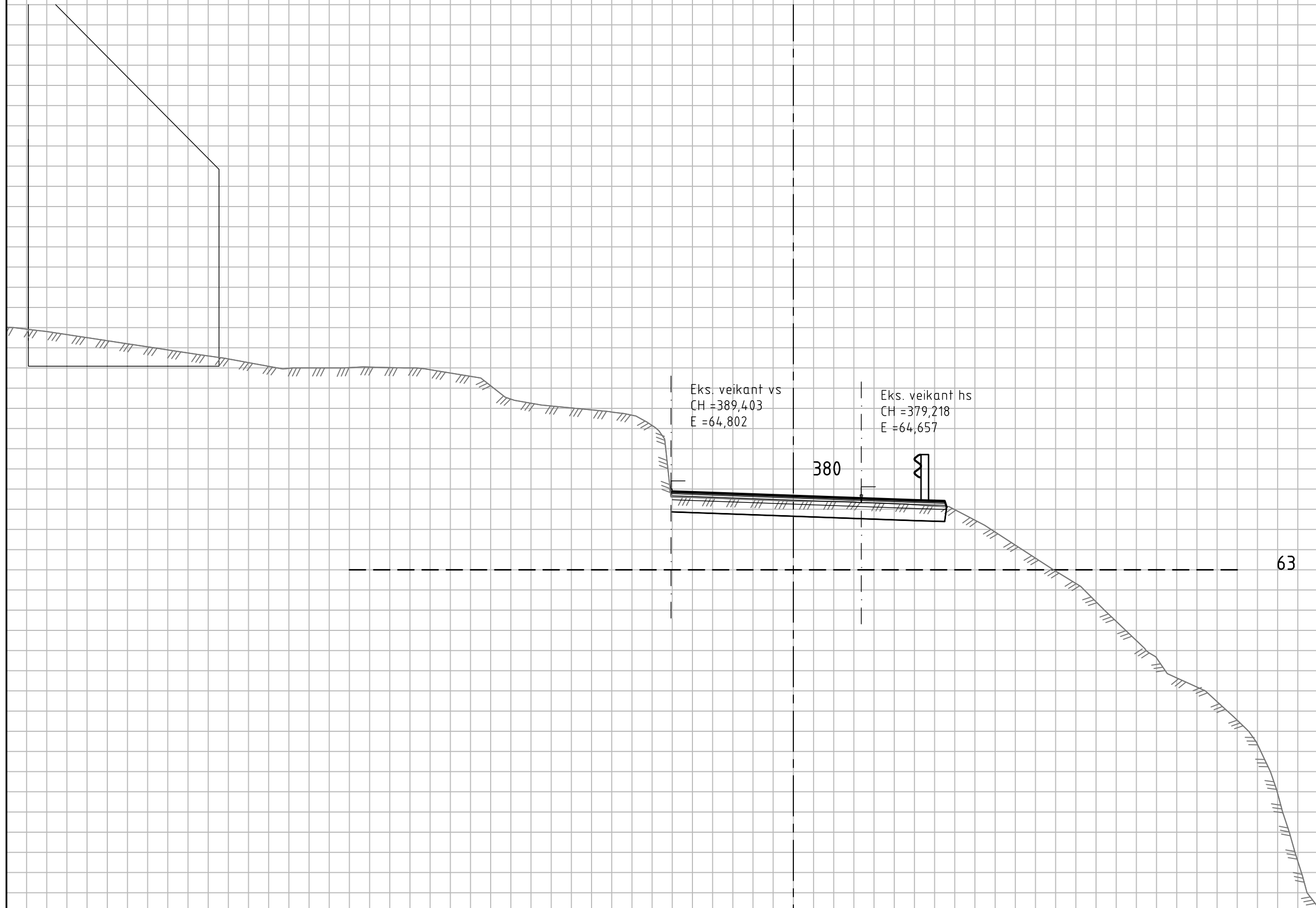

Status	Rev.	Endring	Utført	Kontr.	Ansv.	Dato
			nomton	nourda	nokats	20.06.2024
Arkitektgruppen Cubus AS			Målestokk	1:100		Format
Bjørnarhallen					A3	
Vegmodell 60000			Oppdragsleder:			
Tverrprofiler			Kathrine Lie Strandos			
Øvre Seimsmark			Oppdragsnr.			
			10222290			
SWECO 		Disiplin:	Løpenummer:	Status	Rev.	
Sweco Norge AS FANTOFVEGEN 14P, 5072 BERGEN TLF.: 55 27 50 00 FAX.: 55 27 50 01		VEG	U039	X	00	

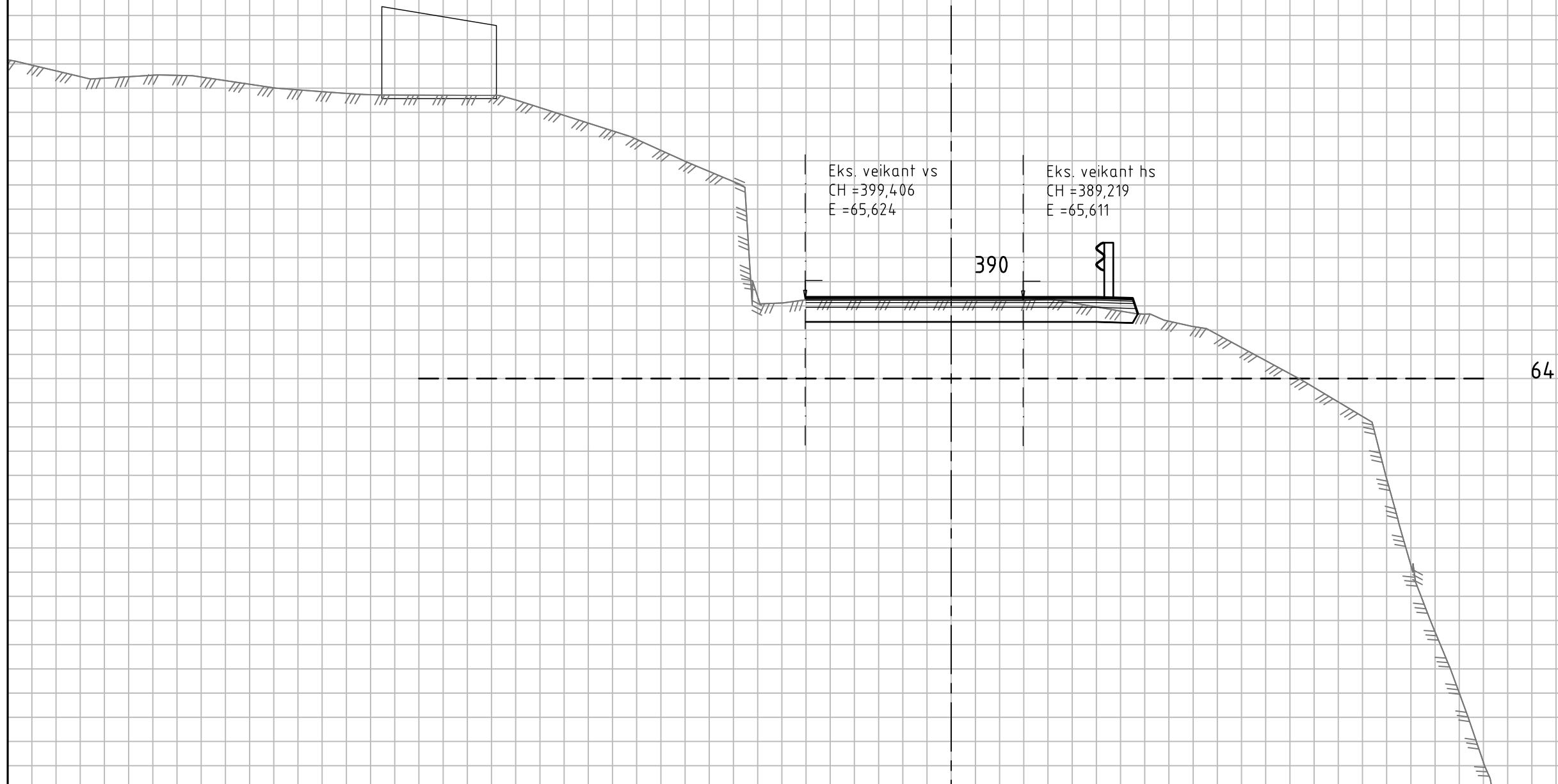

Status	Rev.	Endring	Utført	Kontr.	Ansv.	Dato
		Arkitektgruppen Cubus AS	nomton	nourda	nokats	20.06.2024
		Bjørnarhallen	Målestokk	1:100		Format A3
		Vegmodell 60000	Oppdragsleder: Kathrine Lie Strandos			
		Tverrprofiler	Oppdragsnr. 10222290			
		Øvre Seimsmark	Disiplin:	Løpenummer:	Status	Rev.
		SWECO 	VEG	U040	X	00
		<small>Sweco Norge AS FANTOFTVEGEN 14P, 5072 BERGEN TLF.: 55 27 50 00 FAX.: 55 27 50 01</small>				

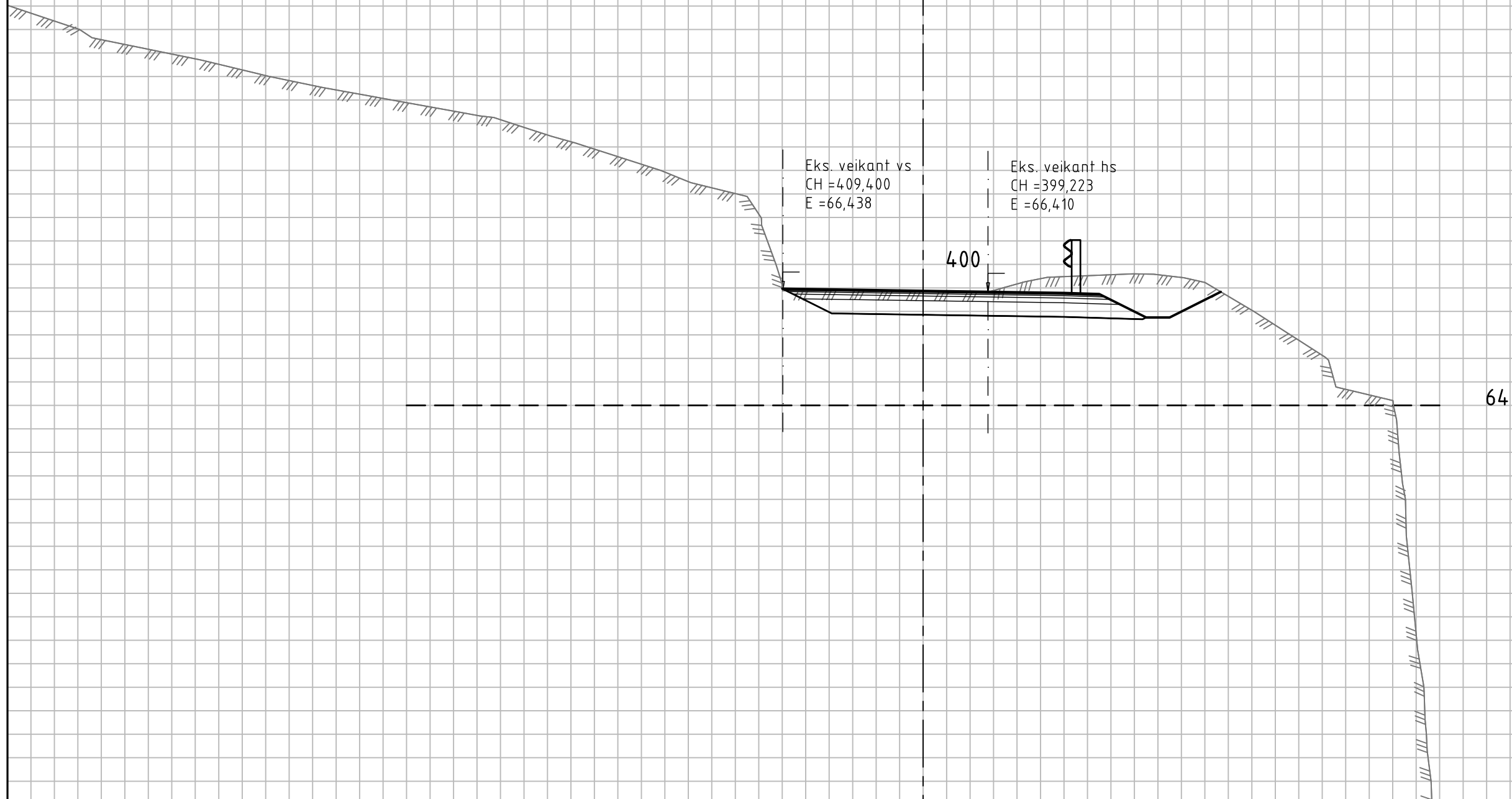

Status	Rev.	Endring	Utført	Kontr.	Ansv.	Dato
		Arkitektgruppen Cubus AS	nomton	nourda	nokats	20.06.2024
		Bjørnarhallen	Målestokk	1:100		Format A3
		Vegmodell 60000	Oppdragsleder: Kathrine Lie Strandos			
		Tverrprofiler	Oppdragsnr. 10222290			
		Øvre Seimsmark	Disiplin:	Løpnummer:	Status	Rev:
		SWECO 	VEG	U041	X	00
		<small>Sweco Norge AS FANTOFTVEGEN 14P, 5072 BERGEN TLF.: 55 27 50 00 FAX.: 55 27 50 01</small>				

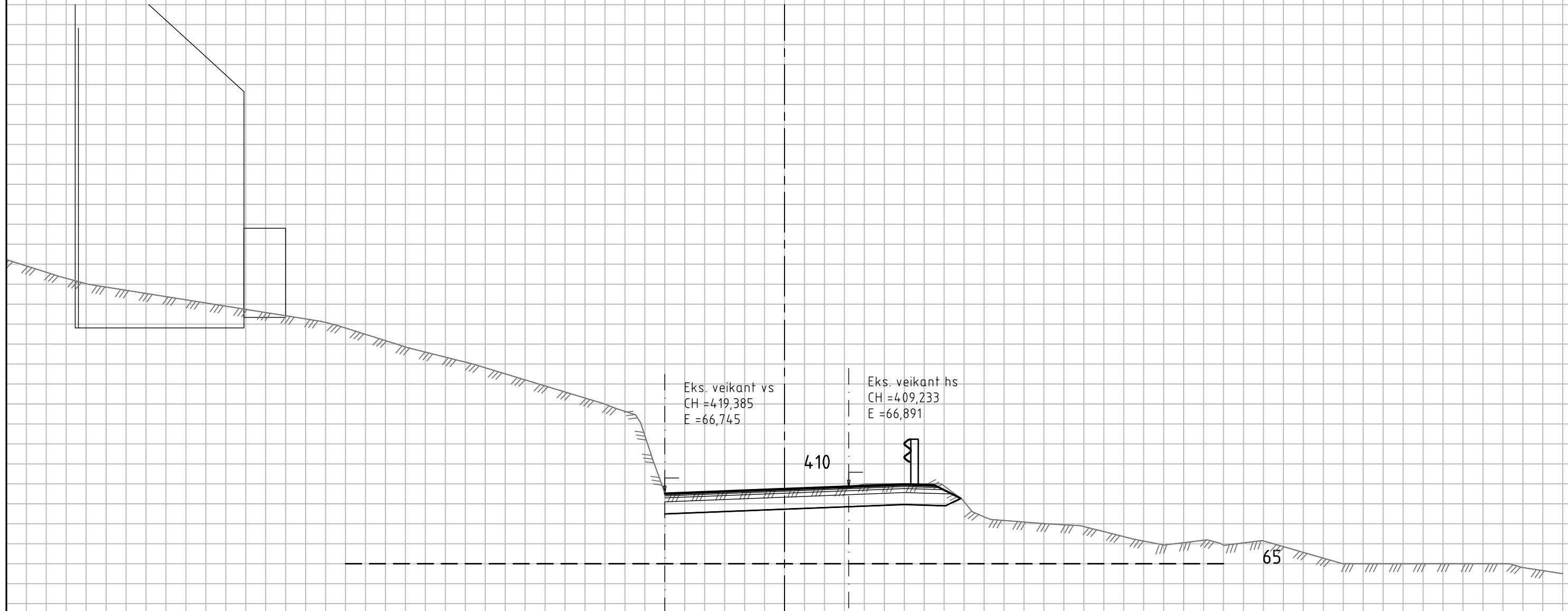

Status	Rev.	Endring	Utført	Kontr.	Ansv.	Dato
		Arkitektgruppen Cubus AS	nomton	nourda	nokats	20.06.2024
		Bjørnarhallen	Målestokk	1:100		Format A3
		Vegmodell 60000	Oppdragsleder: Kathrine Lie Strandos			
		Tverrprofiler	Oppdragsnr. 10222290			
		Øvre Seimsmark	Disiplin:	Løpnummer:	Status	Rev:
		SWECO 	VEG	U042	X	00
		<small>Sweco Norge AS FANTOFTVEGEN 14P, 5072 BERGEN TLF.: 55 27 50 00 FAX.: 55 27 50 01</small>				