

### Tegnforklaring

Eksisterende	Prosjektert	
		Veg
		Fortau/Gangveg
		Nedsenket fortau
		Fortauskant
		Frisikt
		Grøft
		Gnr/Bnr/Fnr
		Eiendomsgrense
		Plangrense
		Rabatt
		Rekkverk

Rev.	Revideringen gjelder	Dato	Tegnet	Kontroll	Godkj.
Oppdragsgiver			Status		
Vestbo Eiendomsutvikling AS			Detaljregulering		
Prosjektnavn			Tegnet	Kontrollert	Godkjent
Fana. Nedre Nøttveit boligfelt. Bergen - Gnr/Bnr. 88/84			VJ	THF	THF
Vegplan			Målestokk A3	1:750	
			Koordinatsystem	EUREF89 UTM32 NN2000	
			Prosjektnr.	Dato	
Kanalveien 5 5068 Bergen Org. nr. 911 566 664 Tlf : +47 55 59 82 60 E-post : post@haugenvva.no Web : www.haugenvva.no			25015	10.09.2025	
			Tegningsnr.	Fag	Rev.
			B001	Vei	

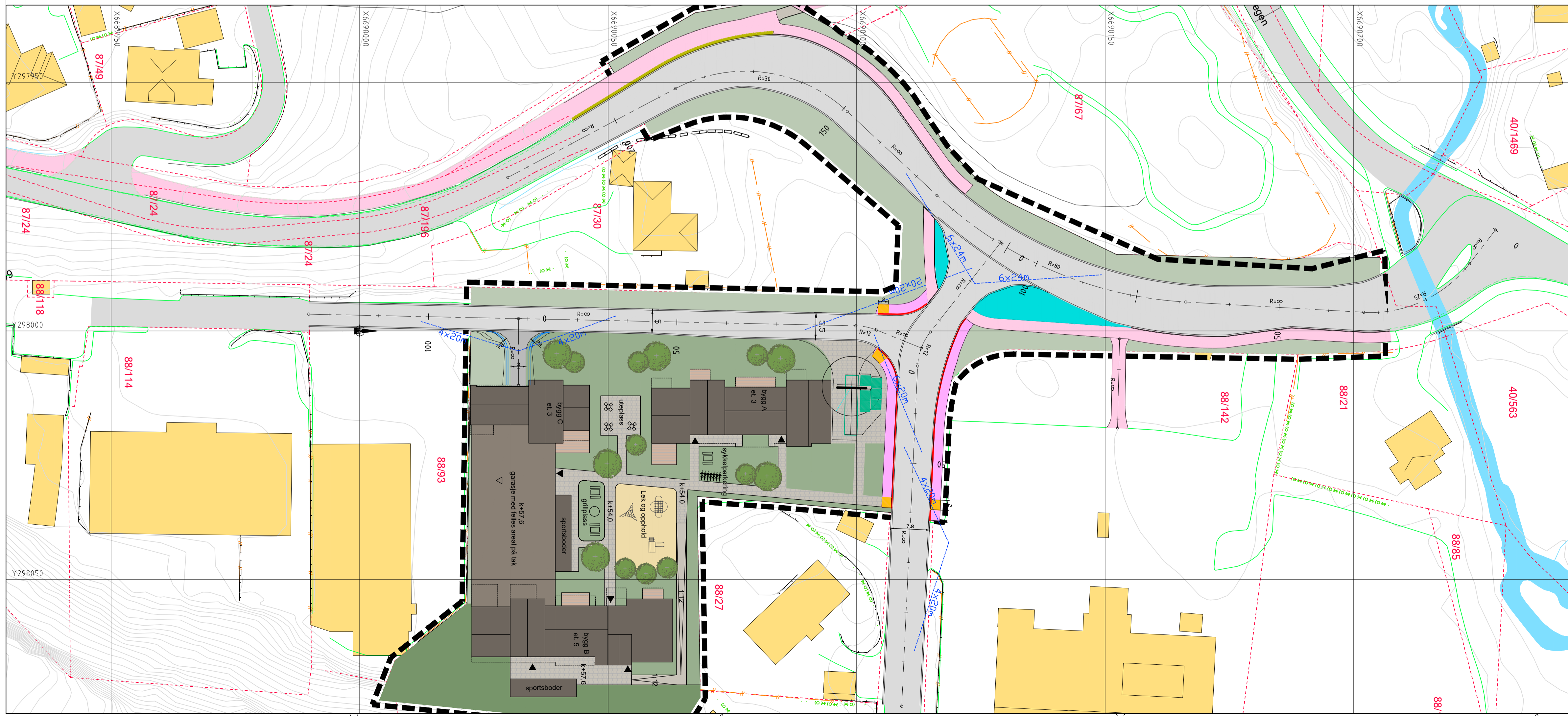

### Tegnforklaring

Eksisterende	Prosjektert	
		Veg
		Fortau/Gangveg
		Nedsenket fortau
		Fortauskant
		Frisikt
		Grøft
		Gnr/Bnr/Fnr
		Eiendomsgrense
		Plangrense
		Rabatt
		Rekkverk

Rev. Revideringen gjelder	Dato	Tegnet	Kontroll	Godkj.
Oppdragsgiver	Status			
Nedre Nøtveit Eiendom AS	Detaljregulering			
Prosjektnavn	Tegnet	Kontrollert	Godkjent	
Fana, Nedre Nøtveit boligfelt, Bergen - Gnr/Bnr. 88/84	VJ	THF	THF	
Plan og lengdeprofil	Målestokk A1	Koordinatsystem		
Parkering innkjøring personbil (P)	1:500/100	EUREF89 UTM32 NN2000		
	Prosjektør	Dato	Rev.	
	25015	10.09.2025		
	Tegningnr.	Fag		
	C001	Ve		

Nedre Nøttveit sør

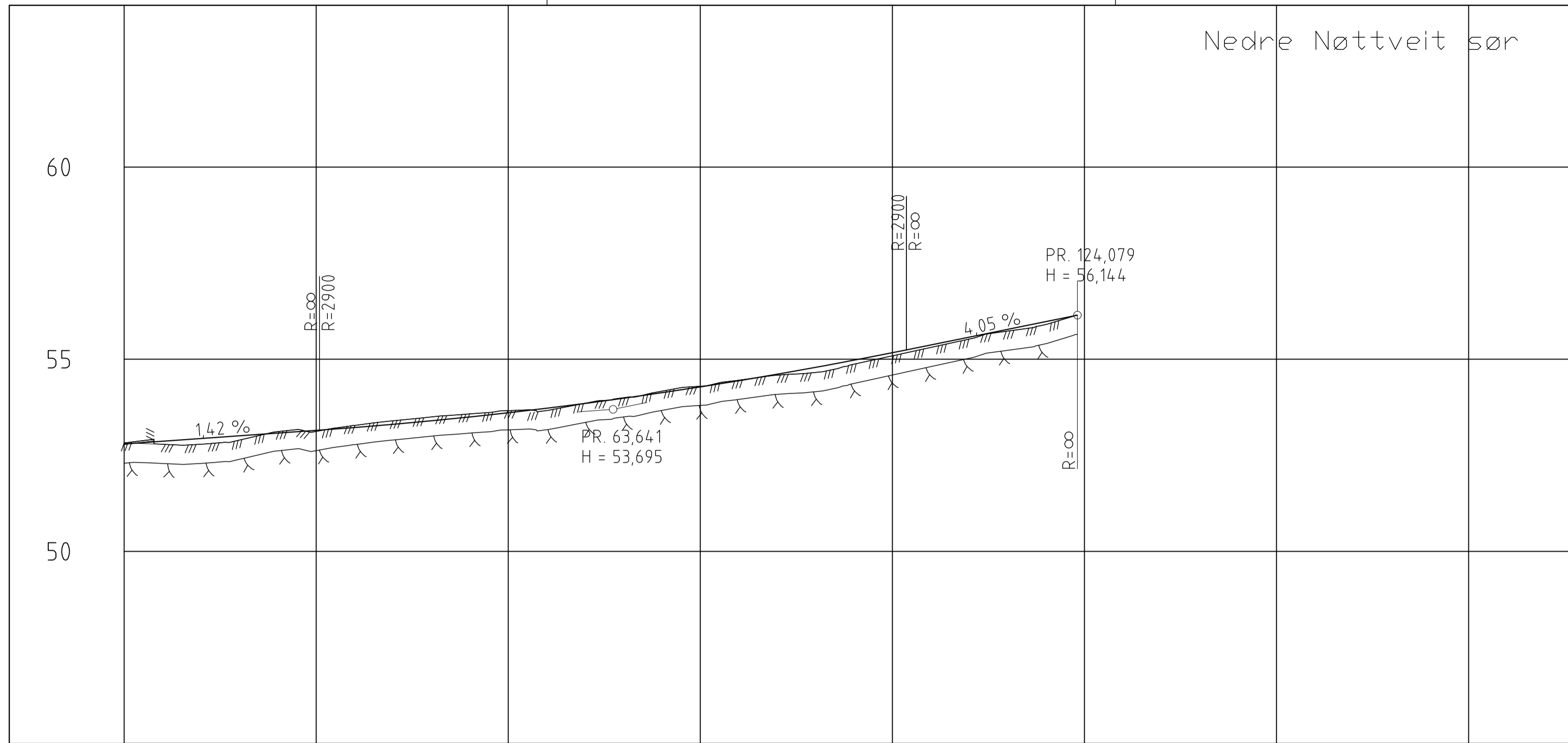

PROFIL NR.	0	25	50	75	100	125	150	175
HOR.KURV.	R=∞		R=-12		R=∞		R=∞	
BREDEUTV.	0,00m		0,50m					
TVERRFALL	2,4%		2,4%		1,0%		3,0%	
H.kj.b.k.	0,6%		2,4%		1,0%		3,0%	
V.kj.b.k.								
PROFIL H.	52,79	52,86	52,94	53,01	53,08	53,15	53,22	53,31
TERRENG H.	52,79	52,86	52,94	53,01	53,08	53,15	53,22	53,31
OVERBYGN.T.	4CM		4CM		4CM		4CM	

Nedre Nøttveit øst

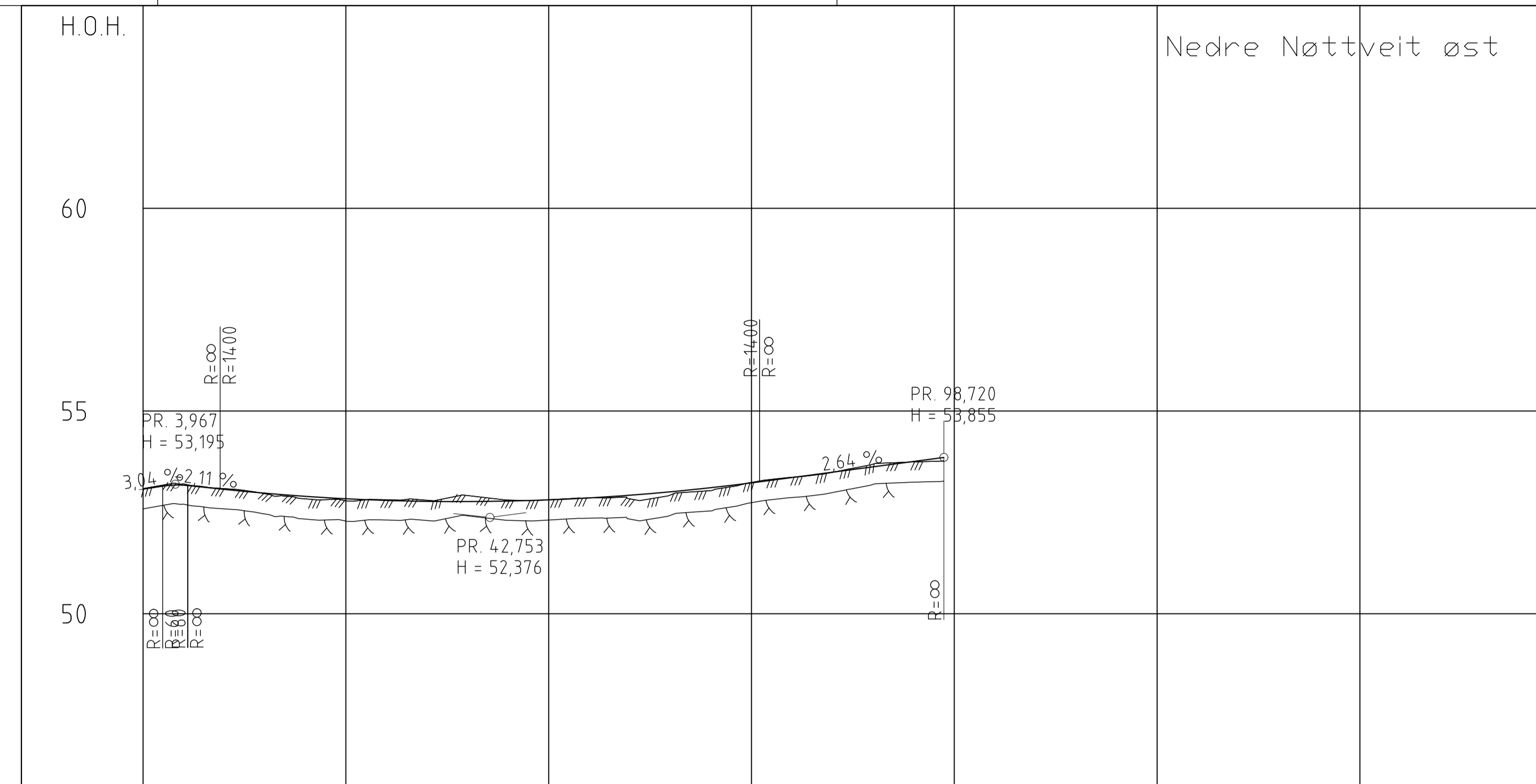

PROFIL NR.	0	25	50	75	100	125	150	
HOR.KURV.	R=∞		R=-12		R=∞		R=∞	
BREDEUTV.	0,00m		0,00m					
TVERRFALL	5,0%		2,5%		0,0%		1,0%	
H.kj.b.k.	0,0%		2,5%		0,0%		1,0%	
V.kj.b.k.								
PROFIL H.	53,07	53,17	53,07	52,97	52,90	52,84	52,88	
TERRENG H.	53,07	53,17	53,07	52,97	52,90	52,84	52,88	

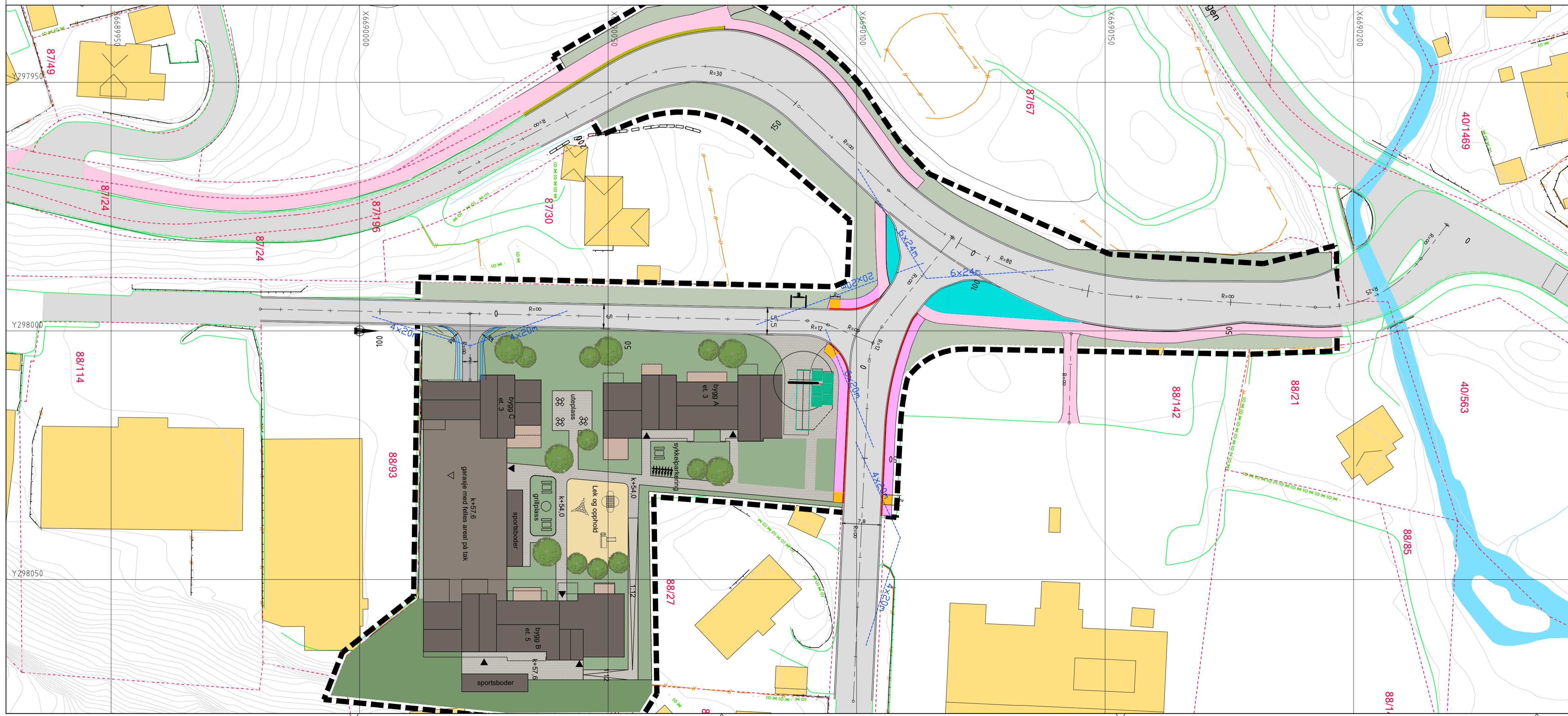

### Tegnforklaring

Eksisterende	Prosjektert	
		Veg
		Fortau/Gangveg
		Nedsenket fortau
		Fortauskant
		Frisikt
		Grøft
		Gnr/Bnr/Fnr
		Eiendomsgrense
		Plangrense
		Rabatt
		Rekkverk

Rev. Revideringen gjelder	Dato	Tegnet	Kontroll	Godkj.
Oppdragsfører	Status			
Nedre Nøttveit Eiendom AS				Detailregulering
Fana, Nedre Nøttveit boligfelt, Bergen - Gnr/Bnr. 88/84				Tegnet VJ
Plan og lengdeprofil Nedre Nøttveit private vegar				Kontrollert THF
Målestokk A1				Godkjent THF
1:500/100				
Koordinatsystem				EUREF89 UTM32 NN2000
haugenwv				Prosjektør
Kanalveien 5, 5068 Bergen, Org. nr. 911 566 664, Tlf. +47 55 59 82 60, E-post: post@haugenvva.no, Web: www.haugenvva.no				Dato
				10.09.2025
				Fag
				Vei
				Rev.
				C003

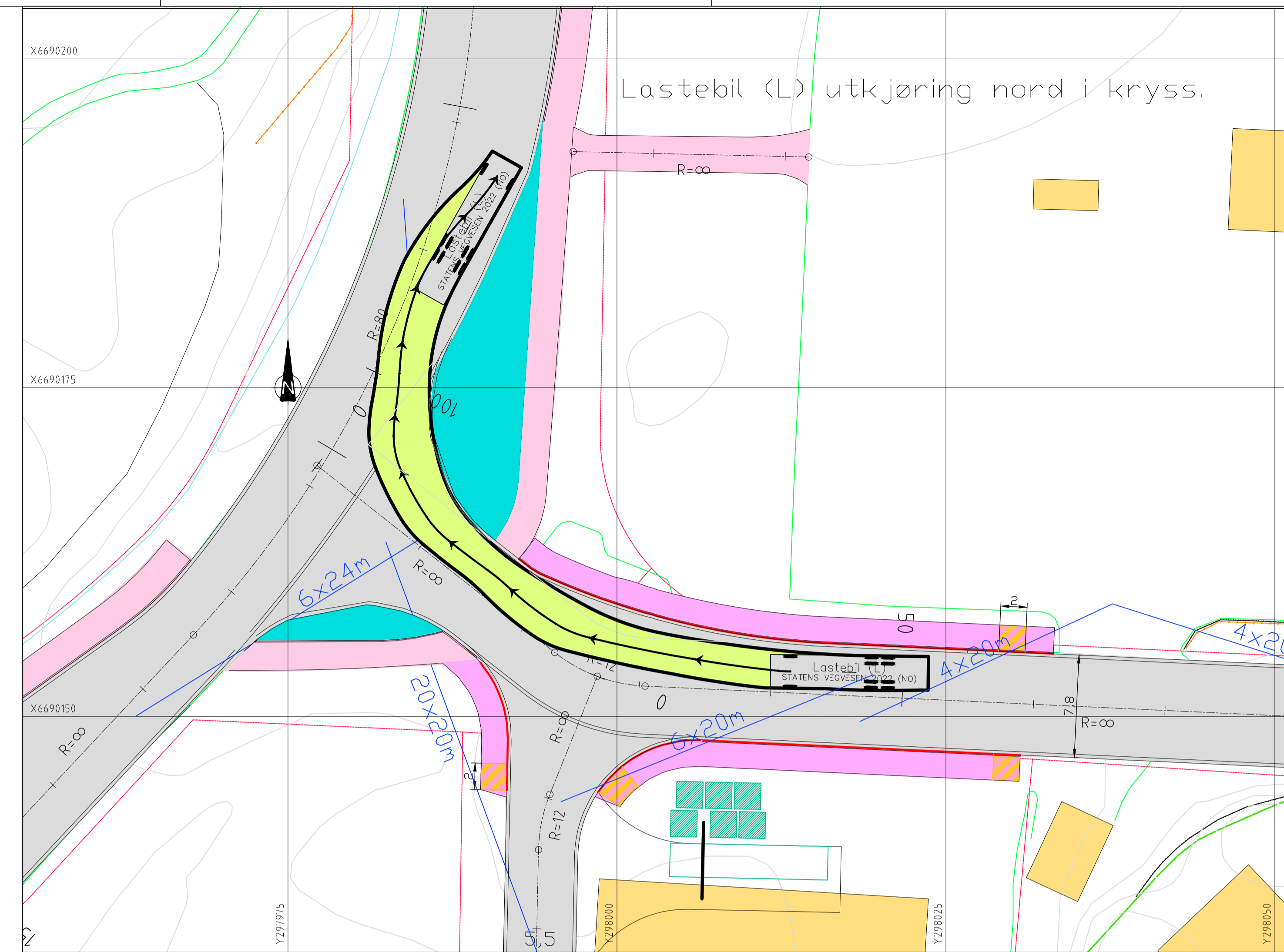
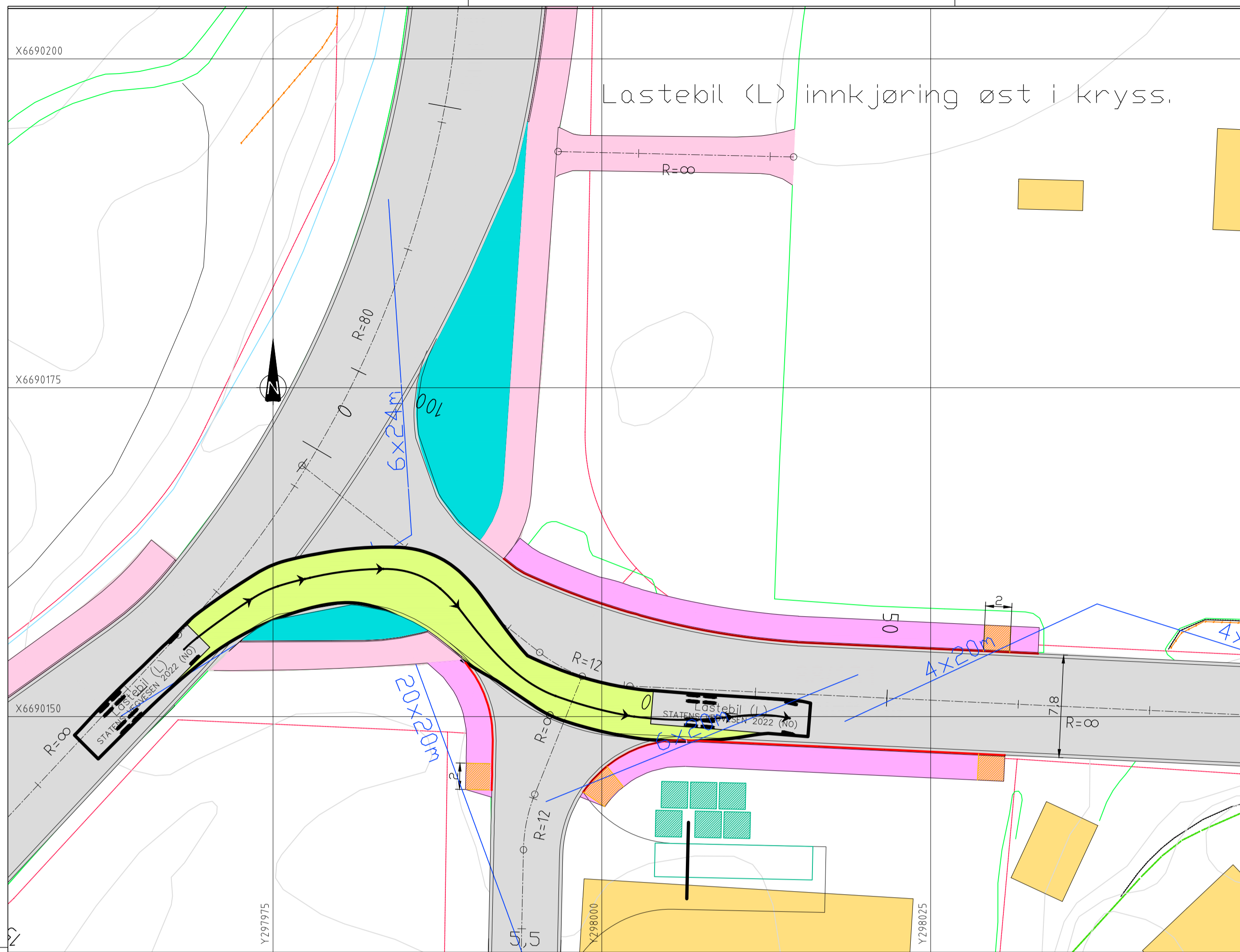

### Tegnforklaring

Prosjektert



Dimensjonerende kjøretøy (lastebil)



Sporingskurve

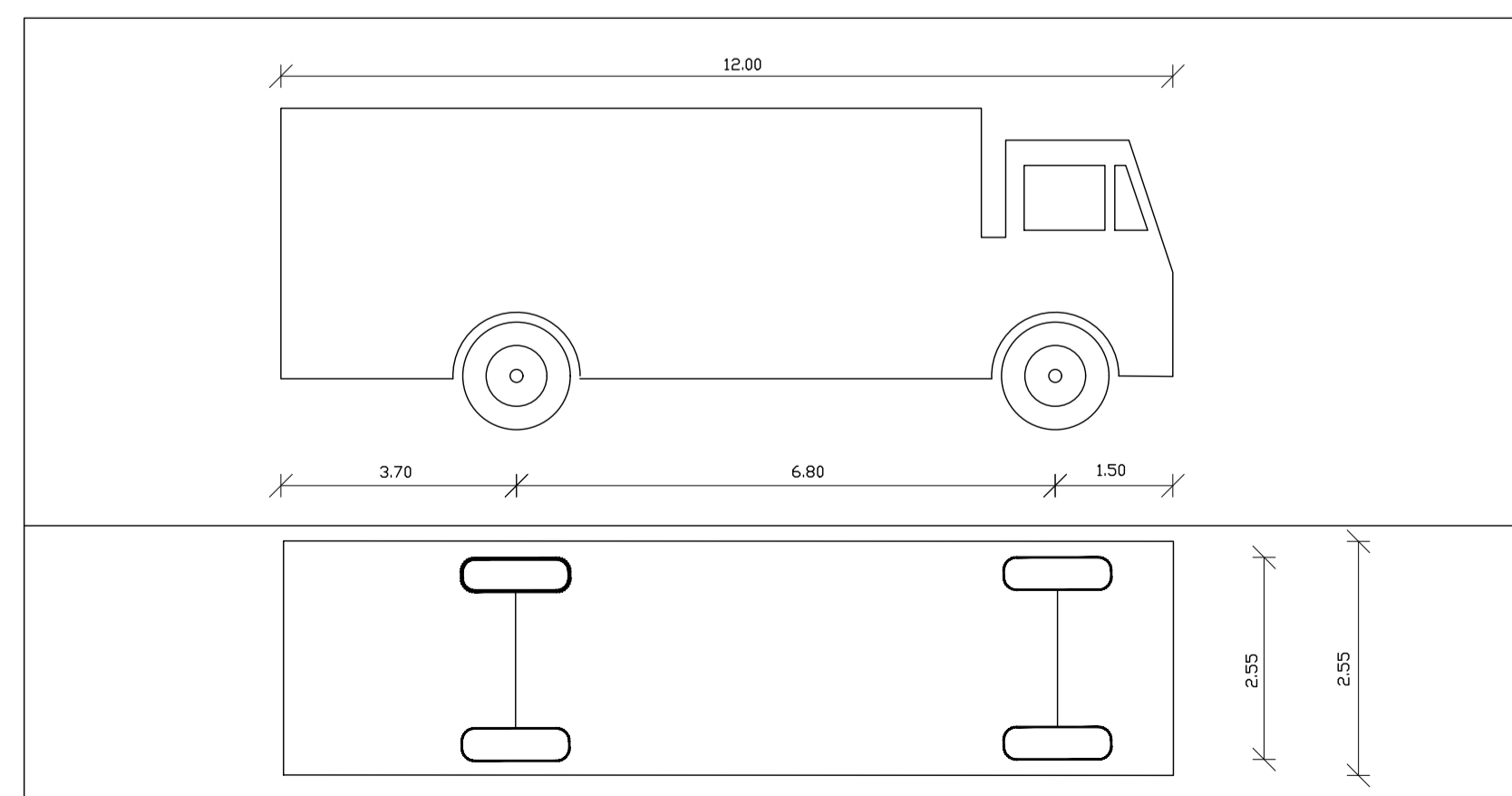

Standard: Norway, Name: 2018 Lastebil (L), Svv HbN100, Total length: 12.00(m)

Rev.	Revideringen gjelder	Dato	Tegnet	Kontroll	Godkj.
Oppdrags-giver	Nedre Nøttveit Eiendom AS		Status		
Prosjekt-navn	Fana. Nedre Nøttveit boligfelt. Bergen - Gnr/Bnr. 88/84		Detaljregulering		
Tegnet	VJ	Kontrollert	THF	Godkjent	THF
Målestokk	A1		1:250		
Koordinat-system	EUREF89 UTM32 NN2000				
haugenwv		Kanalveien 5 5068 Bergen Org. nr. 911 566 664 Tlf. +47 55 59 82 60 E-post: post@haugenvva.no Web: www.haugenvva.no	Prosjekt-nr.	25015	
		Dato	10.09.2025		
		Fag	Vei		
		Rev.			

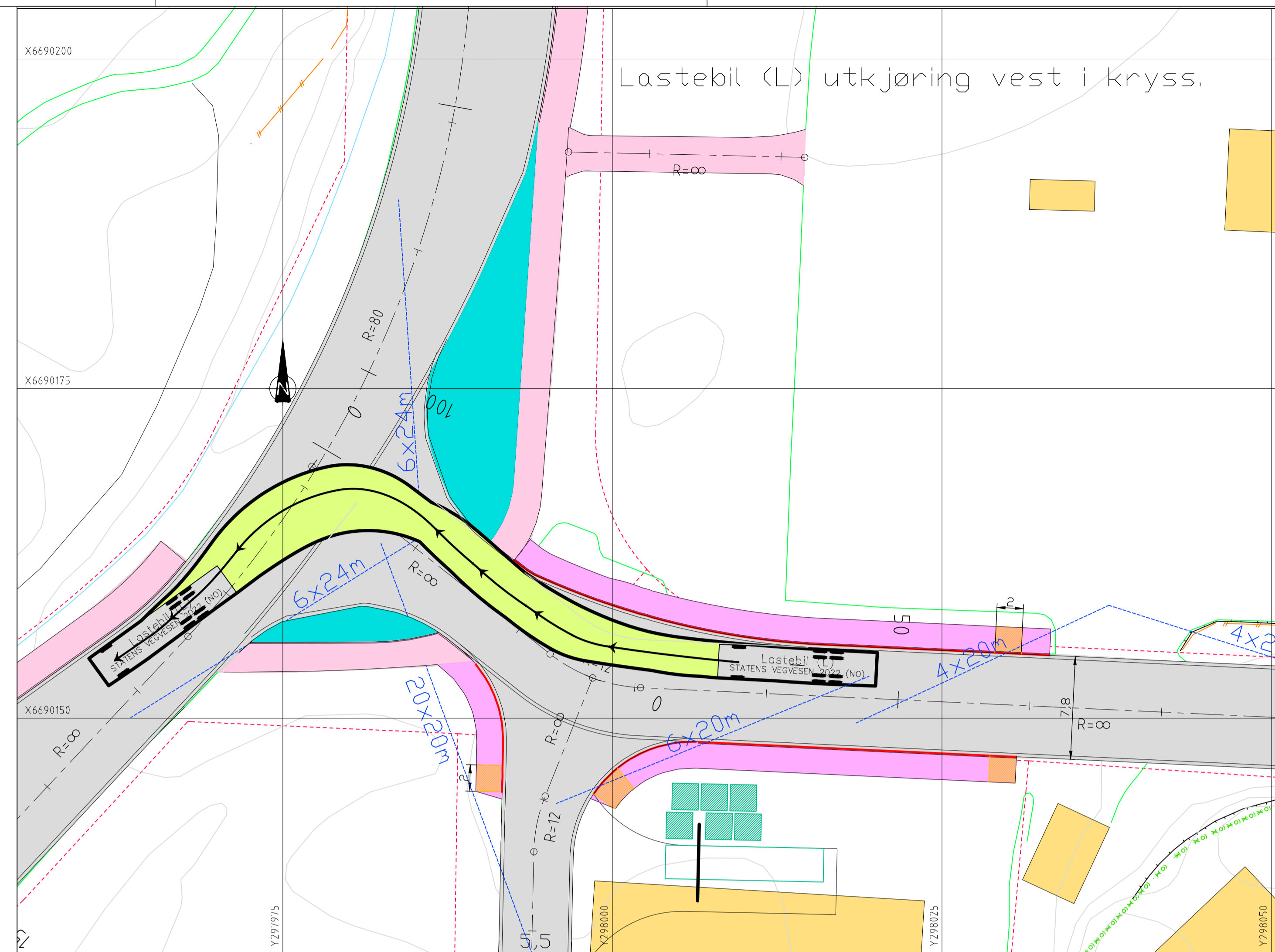
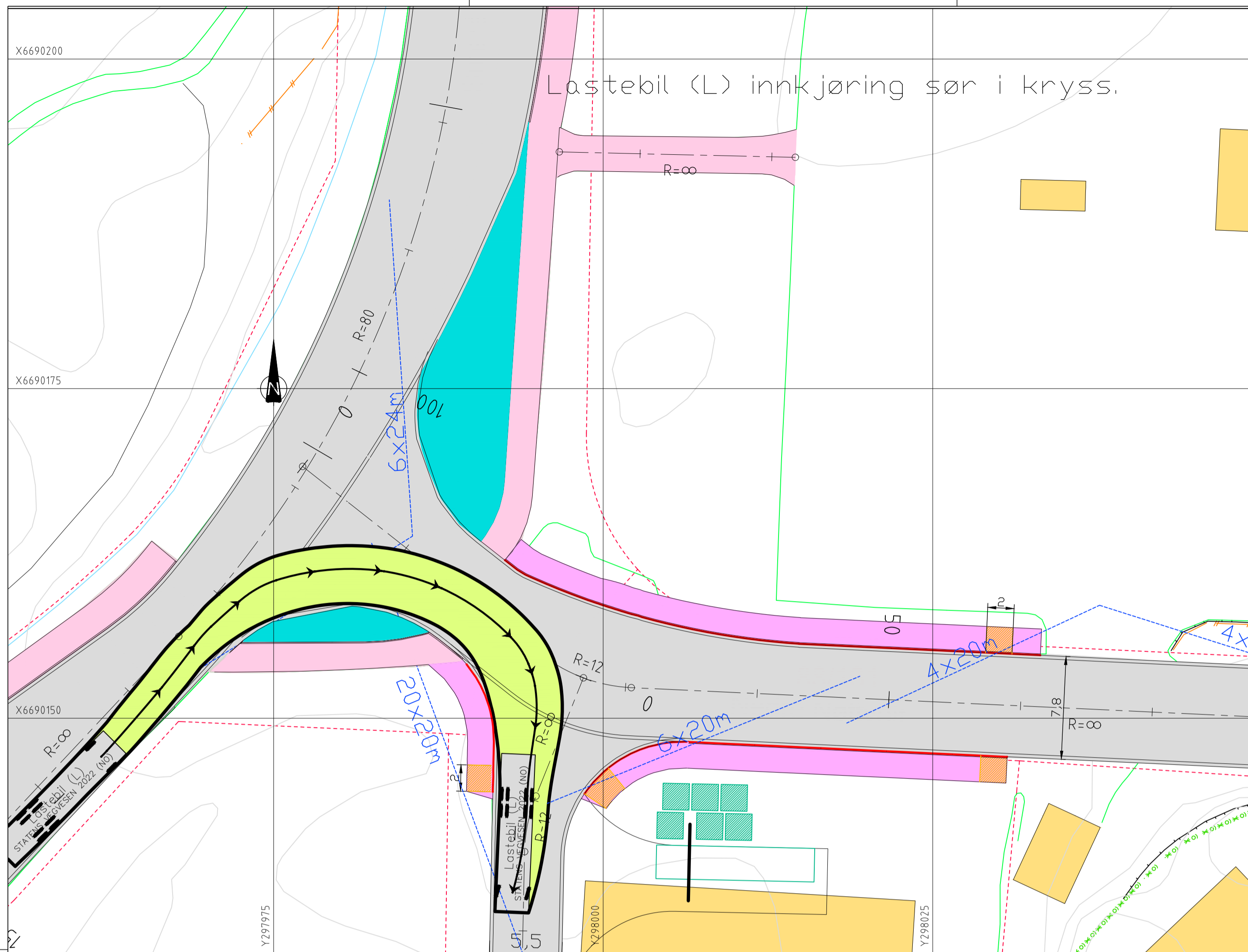

### Tegnforklaring

Prosjektert



Dimensjonerende kjøretøy (lastebil)

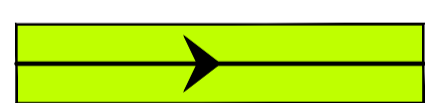

Springskurve

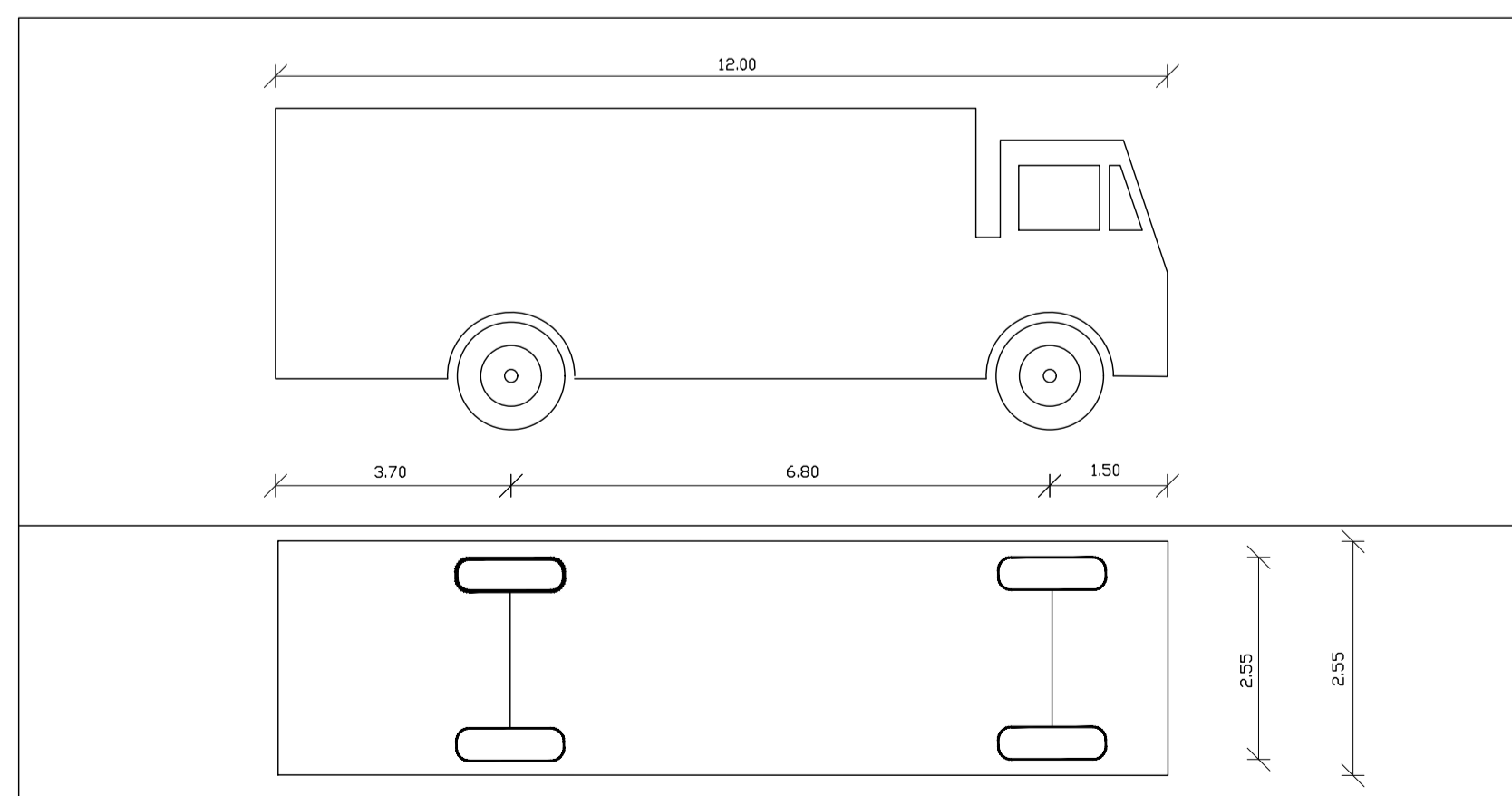

Standard: Norway, Name: 2018 Lastebil (L), Svv HbN100, Total length: 12.00(m)

Rev.	Revideringen gjelder	Dato	Tegnet	Kontroll	Godkj.
	Oppdragsgiver	Status			
	Nedre Nøttveit Eiendom AS	Detaljregulering			
	Prosjektname	Tegnet	Kontrollert	Godkjent	
	Fana, Nedre Nøttveit boligfelt, Bergen - Gnr/Bnr. 88/84	VJ	THF	THF	
	Målestokk A1	1:250			
	Koordinatsystem	EUREF89 UTM32 NN2000			
haugenwv		Kanalveien 5 5068 Bergen Org. nr. 911 566 664 Tlf. +47 55 59 82 60 E-post: post@haugenvv.no Web: www.haugenvv.no	Prosjekt nr.	Dato	Rev.
		25015	10.09.2025		
		5002	Vei		

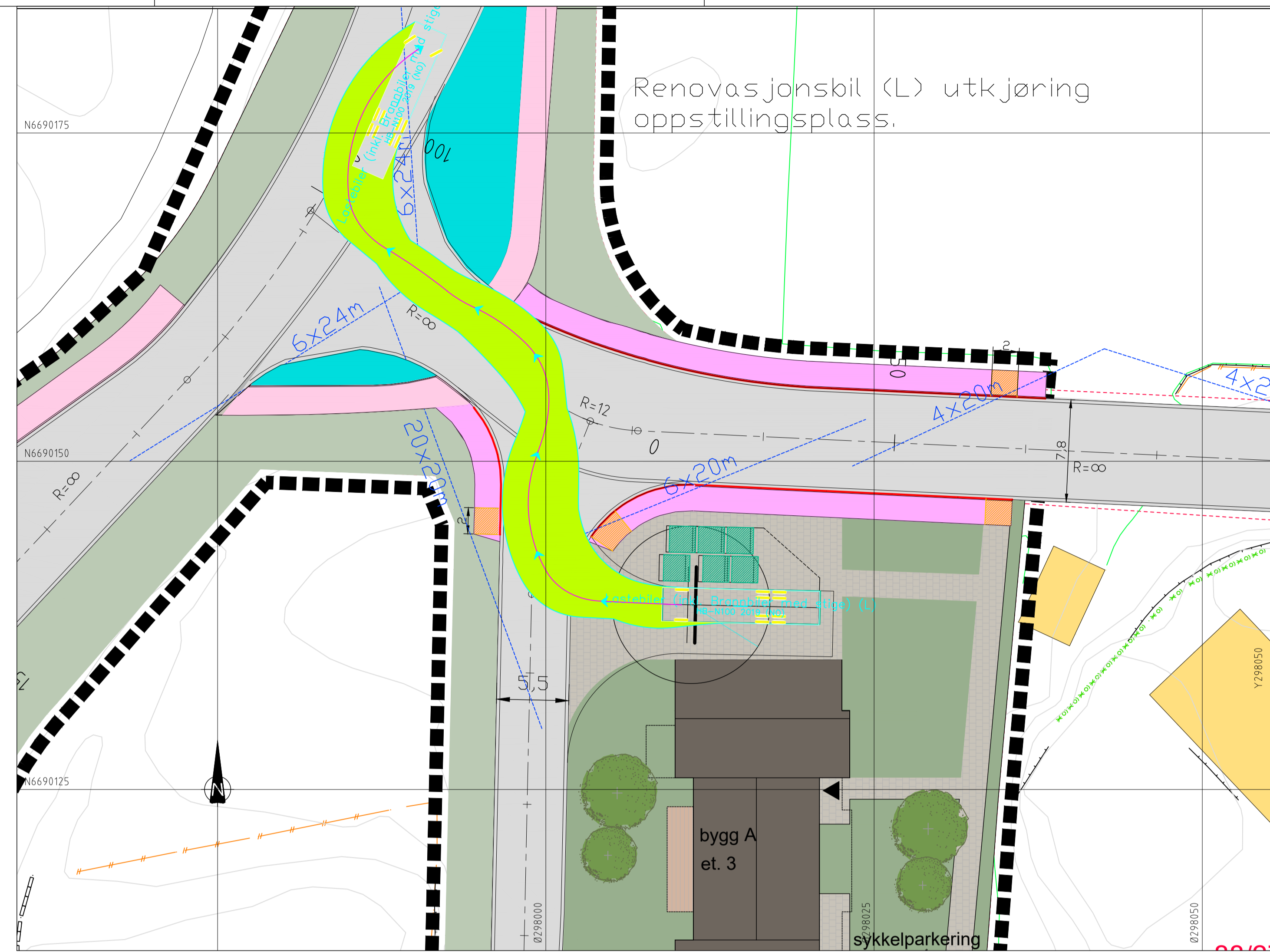
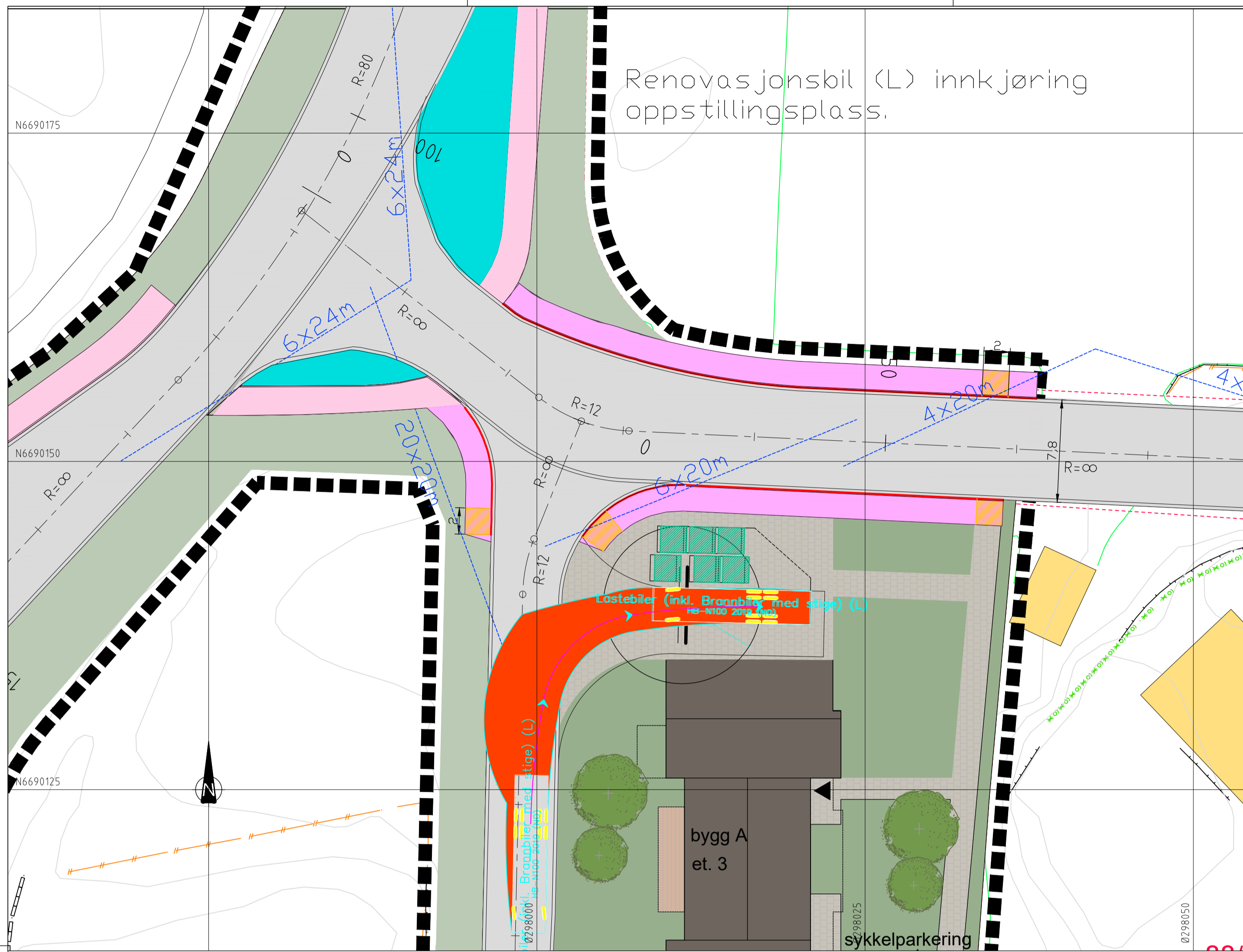

### Tegnforklaring

Prosjektert



Dimensjonerende kjøretøy (lastebil)

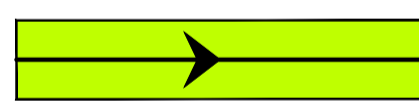

Sporingskurve



Sporingskurve - rygging

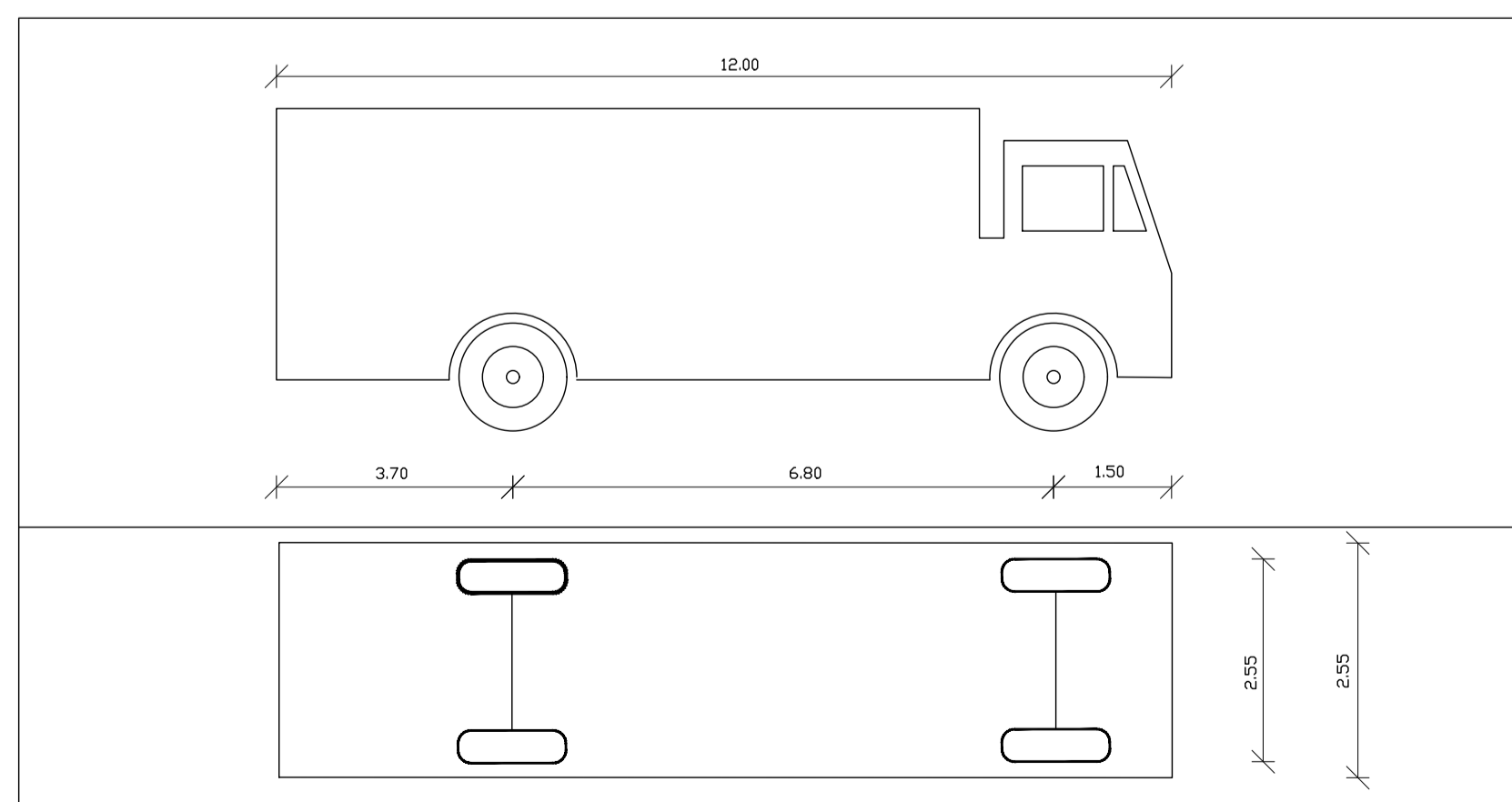

Standard: Norway, Name: 2018 Lastebil (L), Svv HbN100, Total length: 12.00(m)

Rev. Revideringen gjelder	Dato	Tegnet	Kontroll	Godkj.
Oppdragsgiver	Status			
Nedre Nøttveit Eiendom AS	Detaljregulering			
Prosjektname	Tegnet	Kontrollert	Godkjent	
Fana, Nedre Nøttveit boligfelt. Bergen - Gnr/Bnr. 88/84	VJ	THF	THF	
Spøringsanalyse renovasjonsbil (L) Oppstillingsplass	Målestokk A1	Koordinatsystem		
	1:250	EUREF89 UTM32 NN2000		
	Kanalveien 5 5068 Bergen Org. nr. 911 566 664 Tlf. +47 55 59 82 60 E-post: post@haugenvv.no Web: www.haugenvv.no	Prosjekt nr.	Dato	
	25015	10.09.2025		
	Tegningsnr.	Fag	Rev.	
	S003	Vei		

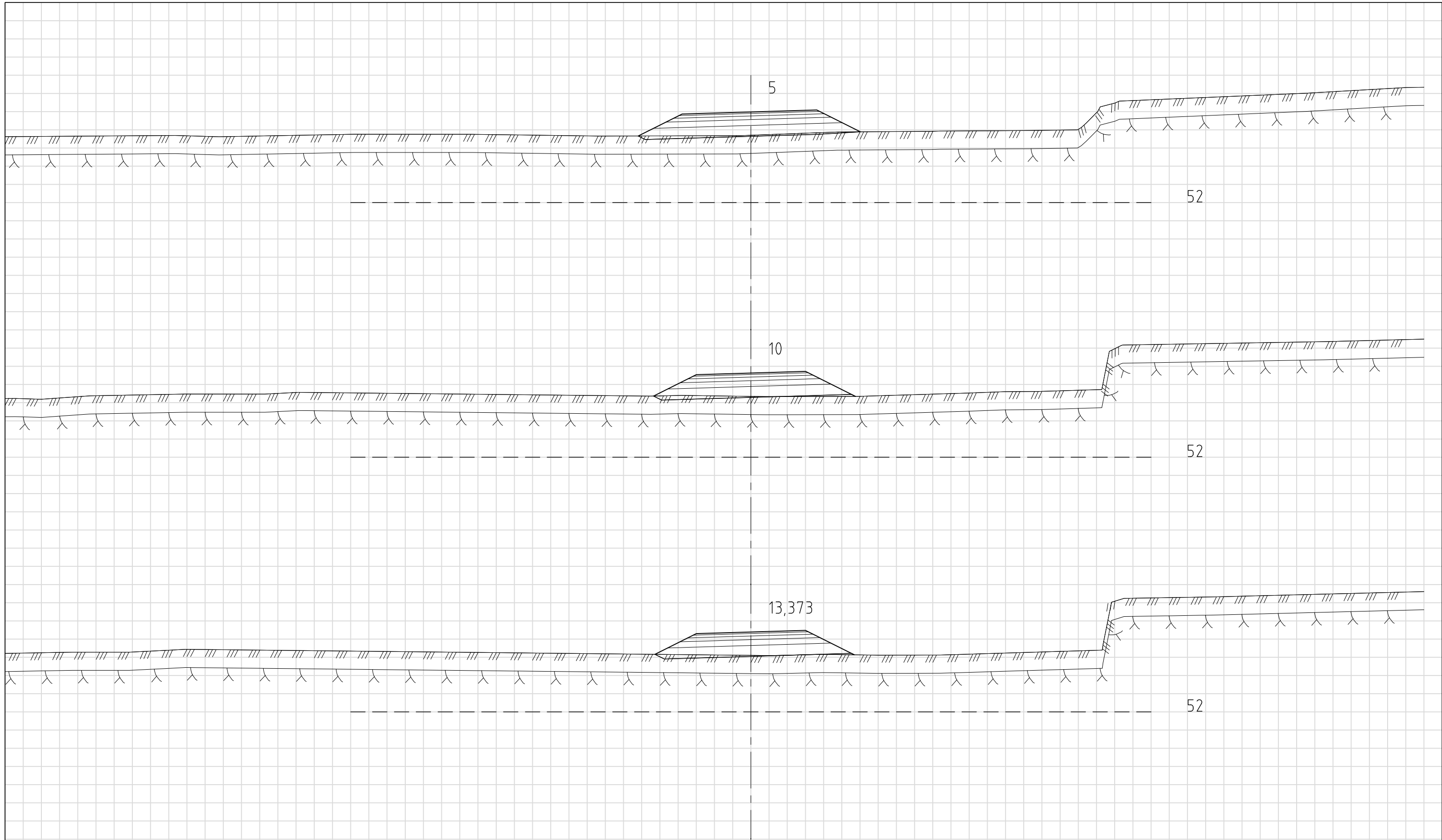

Rev.	Revideringen gjelder	Dato	Tegnet	Kontroll	Godkj.
Oppdragsgiver		Status			
Nedre Nøttveit Eiendom AS		Detaljregulering			
Prosjektnavn		Tegnet	Kontrollert	Godkjent	
Fana. Nedre Nøttveit boligfelt. Bergen - Gnr/Bnr. 88/84		VJ	THF	THF	
Parkering innkjøring personbil (P) Tverrprofiler 5-13,373		Målestokk A3 1:100			
Kanalveien 5 5068 Bergen Org. nr. 911 566 664 Tlf: +47 55 59 82 60 E-post: post@haugenvva.no Web: www.haugenvva.no		Koordinatsystem EUREF89 UTM32 NN2000			
haugen vva		Prosjektnr.	Dato		
		25015	10.09.2025		
		Tegningsnr.	Fag	Rev.	
		U010	Vei		

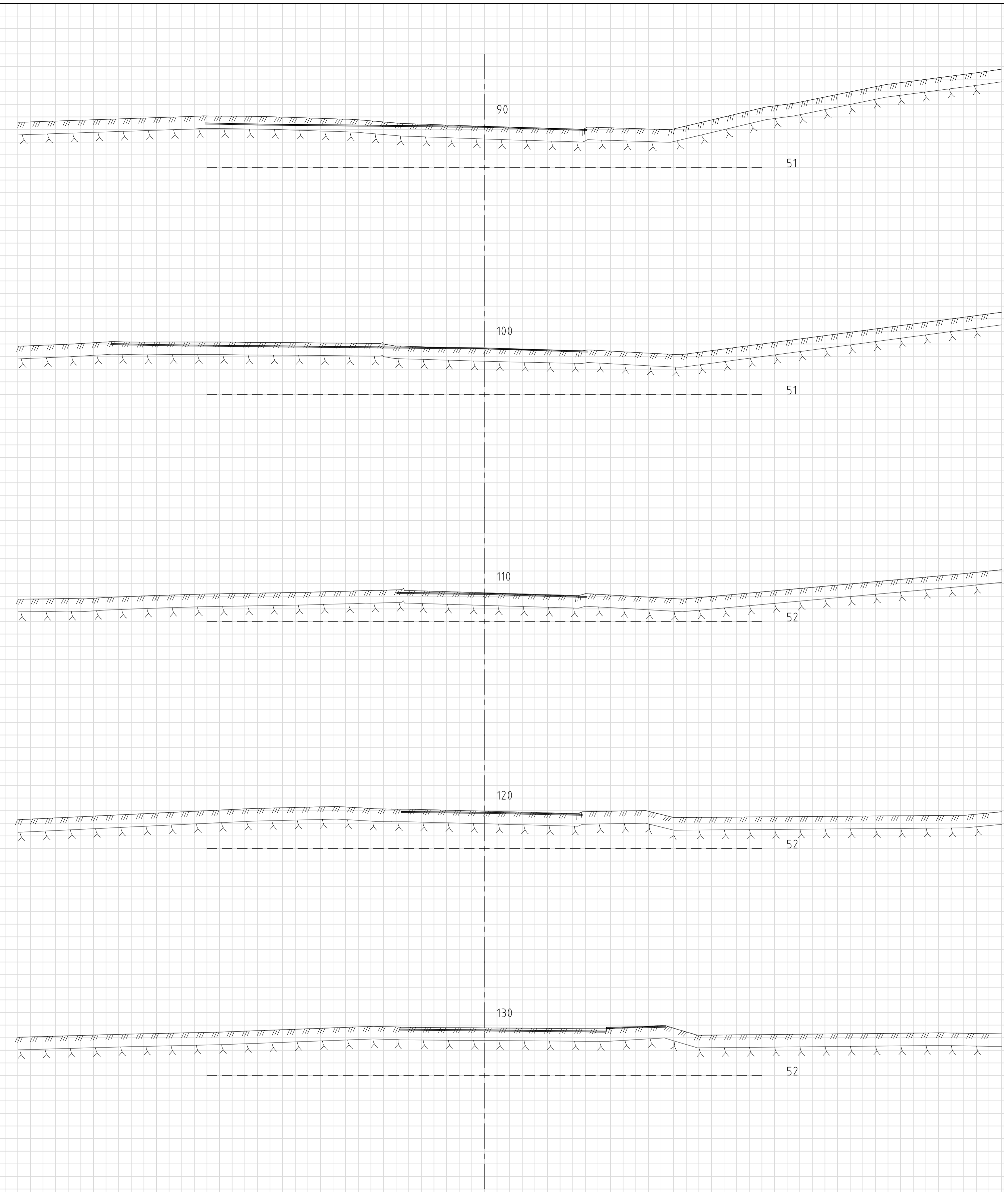
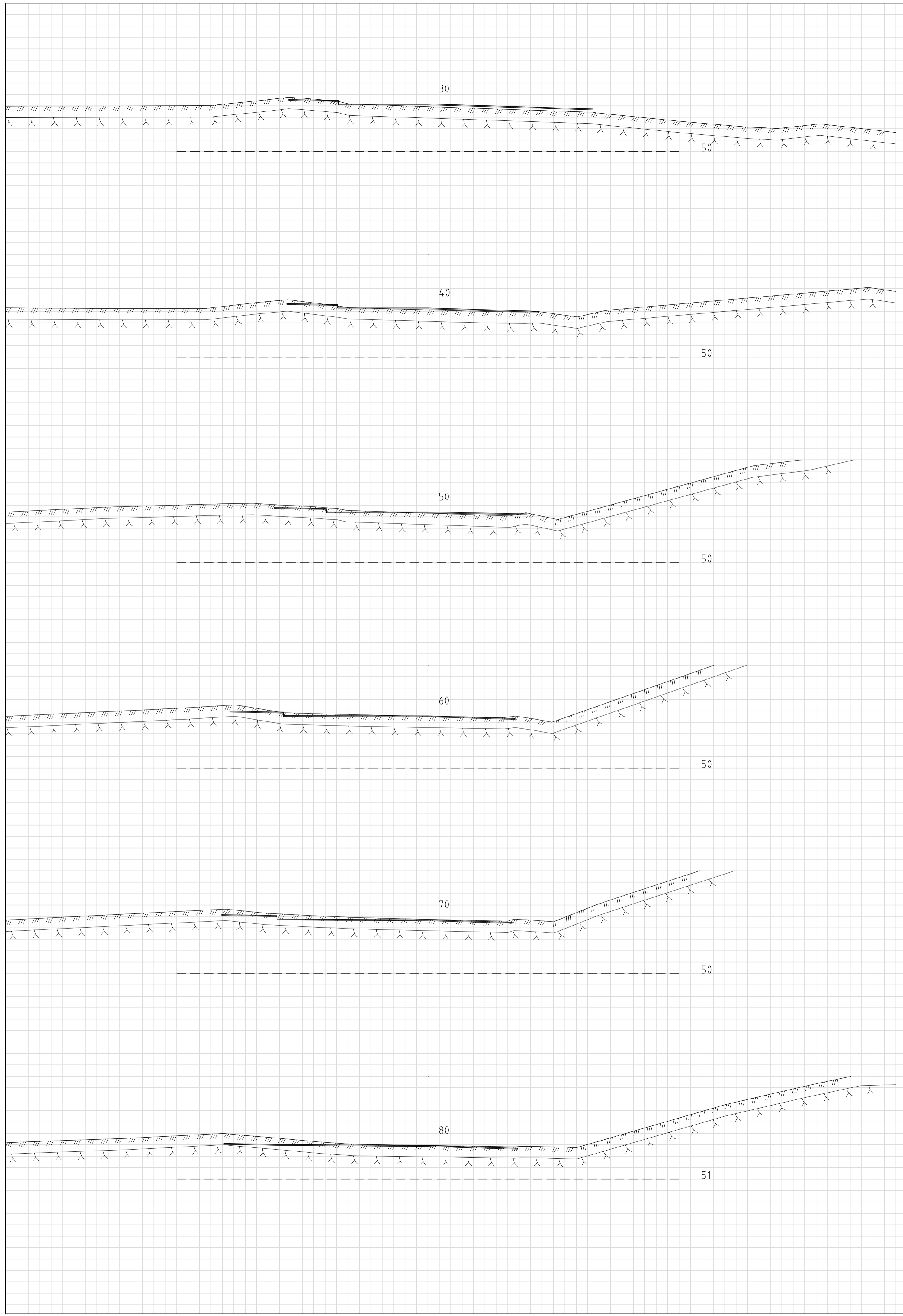

Rev.	Revideringen gjelder	Dato	Tegnet	Kontroll	Godkj.
Oppdragsgiver	Nedre Nøttveit Eiendom AS	Status	Detaljregulering		
Prosjektnavn	Fana. Nedre Nøttveit boligfelt. Bergen - Gnr/Bnr. 88/84	Tegnet	VJ	Kontrollert	THF
		Målestokk A1	1:100		
		Koordinatsystem	EUREF89 UTM32 NN2000		
		Prosjekt nr.	25015	Dato	10.09.2025
		Tegning nr.	U020	Fag	Vei
				Rev.	

Kanalveien 5  
5068 Bergen  
Org. nr. 911 566 664  
Tlf. +47 55 59 82 60  
E-post: post@haugenvva.no  
Web: www.haugenvva.no



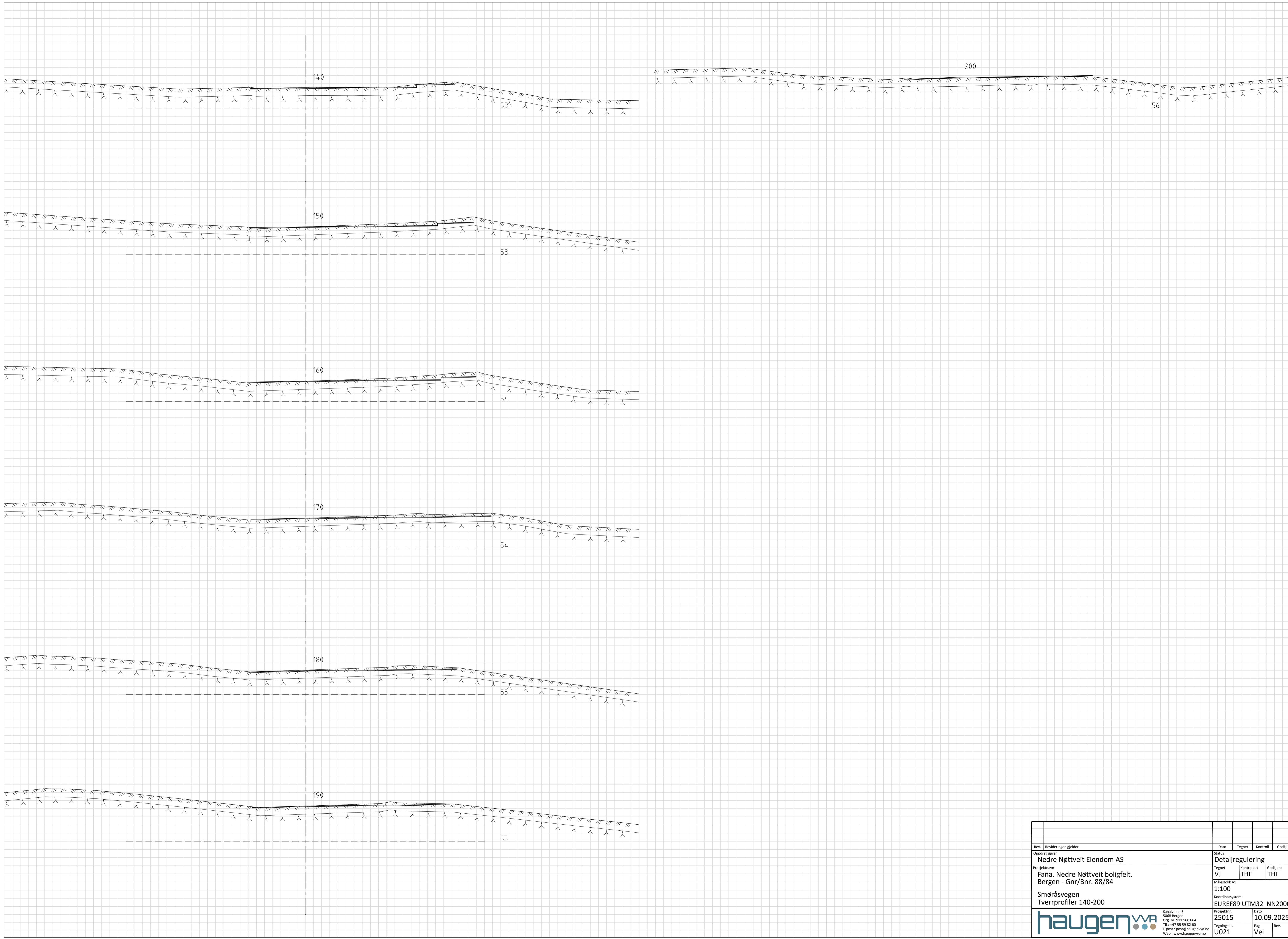

Rev. Revideringen gjelder	Dato	Tegnet	Kontroll	Godkj.
Oppdragsgiver <b>Nedre Nøttveit Eiendom AS</b>	Status <b>Detaljregulering</b>	Tegnet <b>VJ</b>	Kontrollert <b>THF</b>	Godkjent <b>THF</b>
Prosjektnavn <b>Fana. Nedre Nøttveit boligfelt. Bergen - Gnr/Bnr. 88/84</b>	Målestokk A1 <b>1:100</b>	Koordinatsystem <b>EUREF89 UTM32 NN2000</b>		
Smøgråsvegen Tverrprofiler 140-200	Prosjekt nr. <b>25015</b>	Dato <b>10.09.2025</b>		
<b>haugen</b> <small>Kanalveien 5 5068 Bergen Org. nr. 911 566 664 Tlf. +47 55 59 82 60 E-post: post@haugenvva.no Web: www.haugenvva.no</small>	Tegning nr. <b>U021</b>	Fag <b>Vei</b>	Rev.	

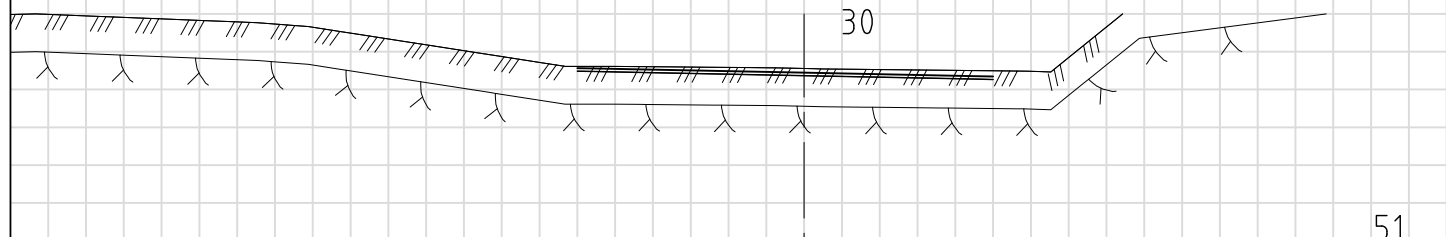
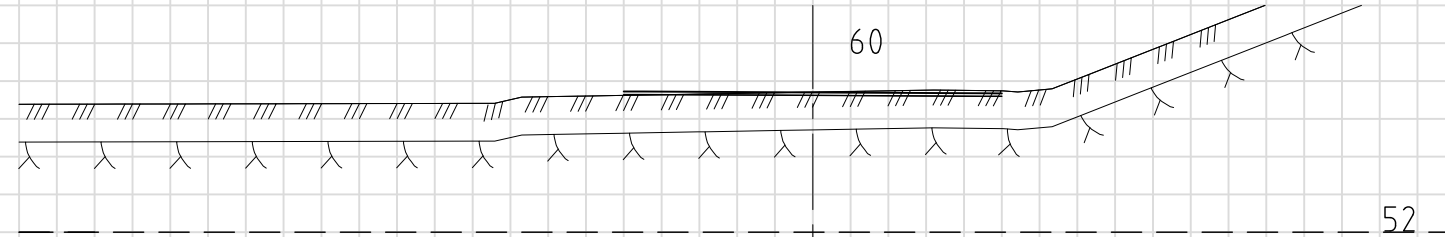
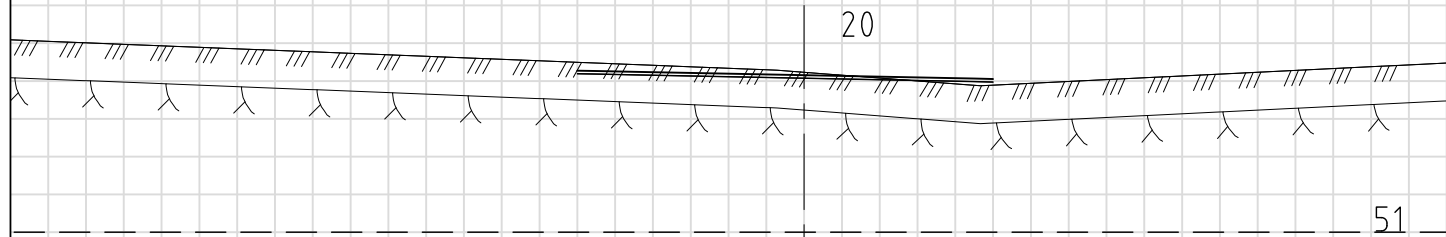
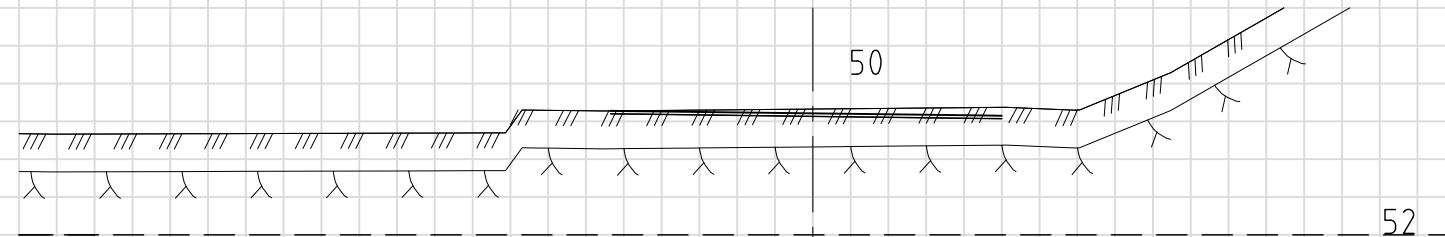
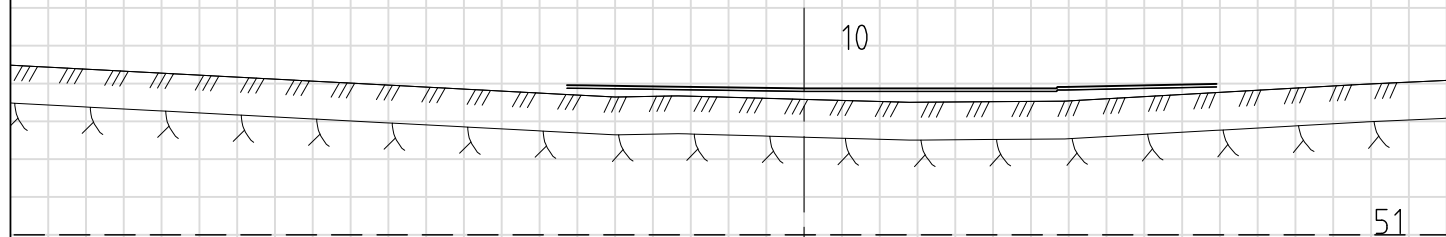
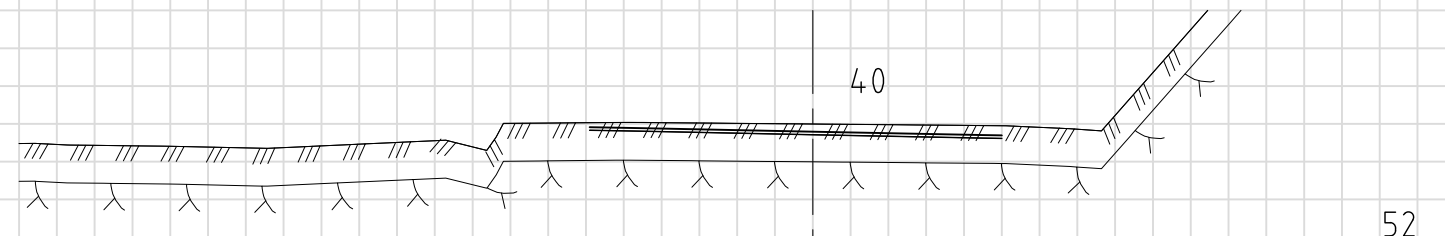
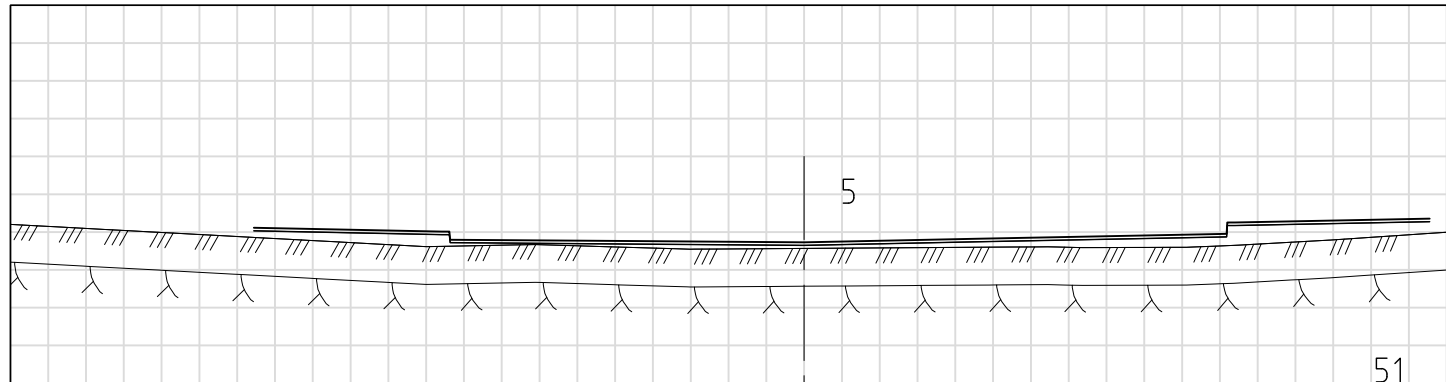

Rev. Revideringen gjelder		Dato	Tegnet	Kontroll	Godkj.
Oppdragsgiver <b>Nedre Nøttveit Eiendom AS</b>		Status <b>Detaljregulering</b>			
Prosjektnavn <b>Fana. Nedre Nøttveit boligfelt. Bergen - Gnr/Bnr. 88/84</b>		Tegnet <b>VJ</b>	Kontrollert <b>THF</b>	Godkjent <b>THF</b>	
Målestokk A3 <b>1:100</b>		Koordinatsystem <b>EUREF89 UTM32 NN2000</b>			
Prosjektnr. <b>25015</b>		Dato <b>10.09.2025</b>			
Tegningsnr. <b>U030</b>		Fag <b>Vei</b>	Rev.		



Kanalveien 5  
5068 Bergen  
Org. nr. 911 566 664  
Tlf: +47 55 59 82 60  
E-post: post@haugenvva.no  
Web: www.haugenvva.no

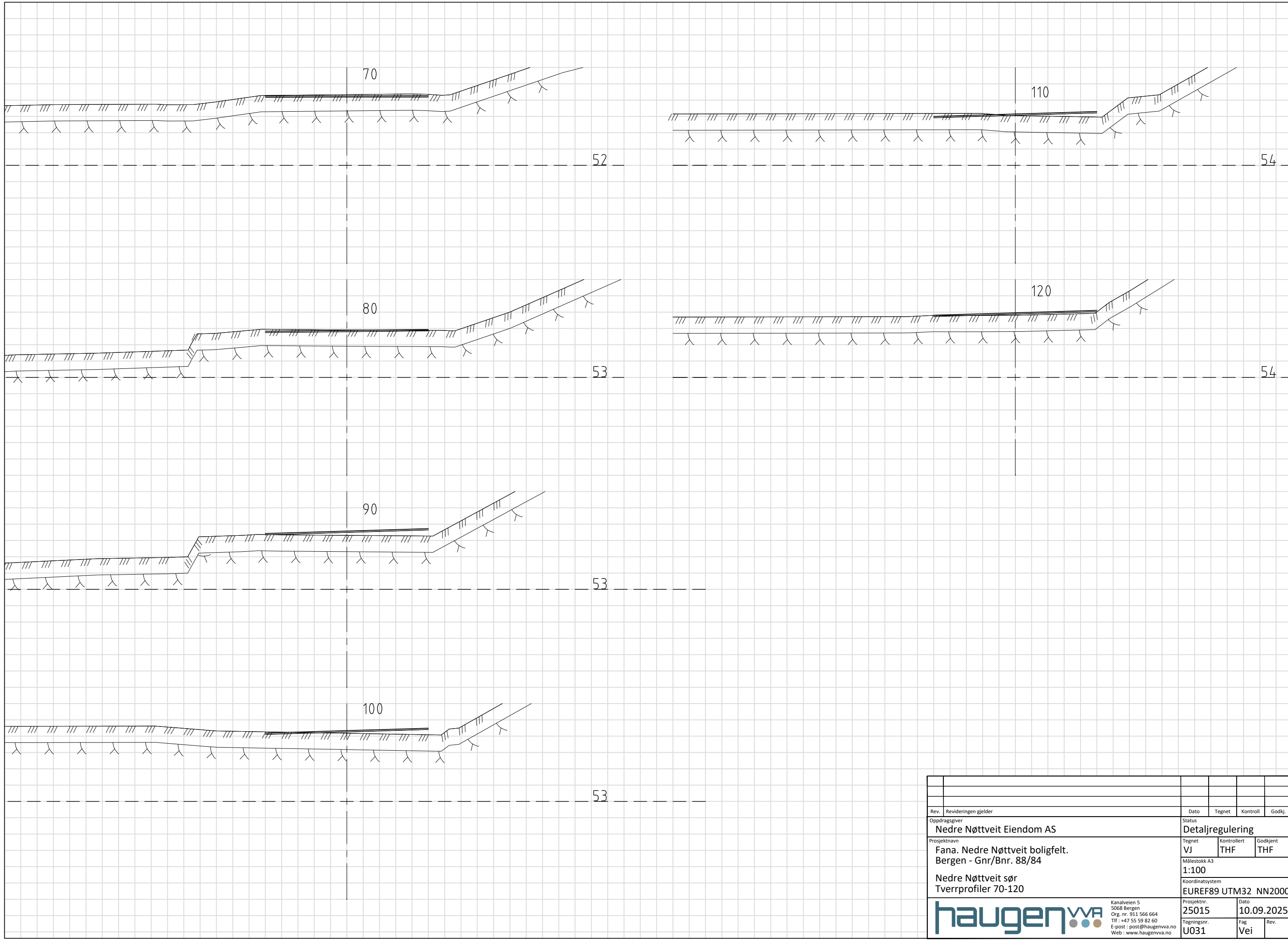

Rev.	Revideringen gjelder	Dato	Tegnet	Kontroll	Godkj.
Oppdragsgiver <b>Nedre Nøttveit Eiendom AS</b>		Status <b>Detaljregulering</b>			
Prosjektnavn <b>Fana. Nedre Nøttveit boligfelt. Bergen - Gnr/Bnr. 88/84</b>		Tegnet <b>VJ</b>	Kontrollert <b>THF</b>	Godkjent <b>THF</b>	
Målestokk A3 <b>1:100</b>		Koordinatsystem <b>EUREF89 UTM32 NN2000</b>			
Prosjektnr. <b>25015</b>		Dato <b>10.09.2025</b>			
Tegningsnr. <b>U031</b>		Fag <b>Vei</b>	Rev.		



Kanalveien 5  
5068 Bergen  
Org. nr. 911 566 664  
Tlf: +47 55 59 82 60  
E-post: post@haugenvva.no  
Web: www.haugenvva.no

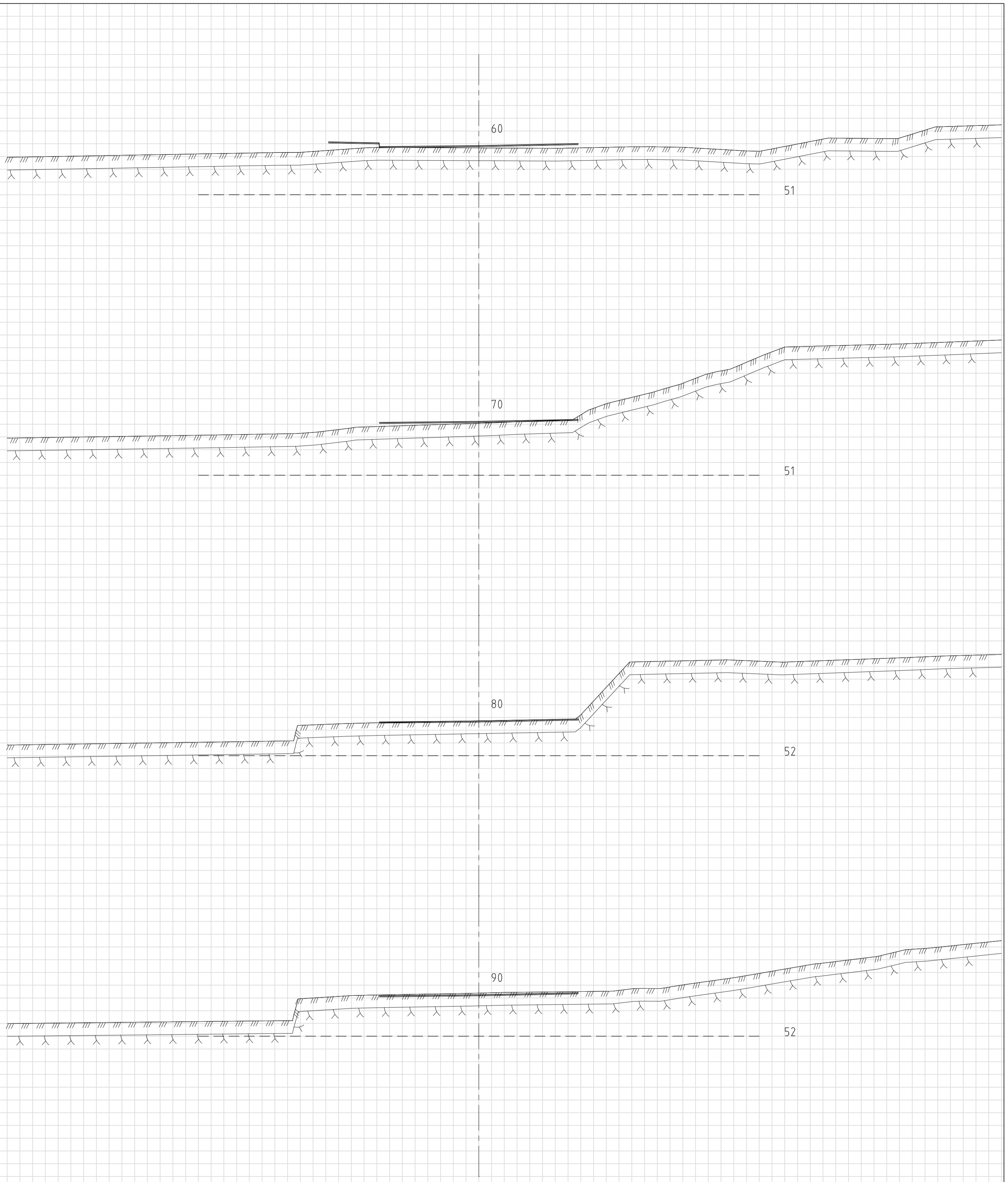
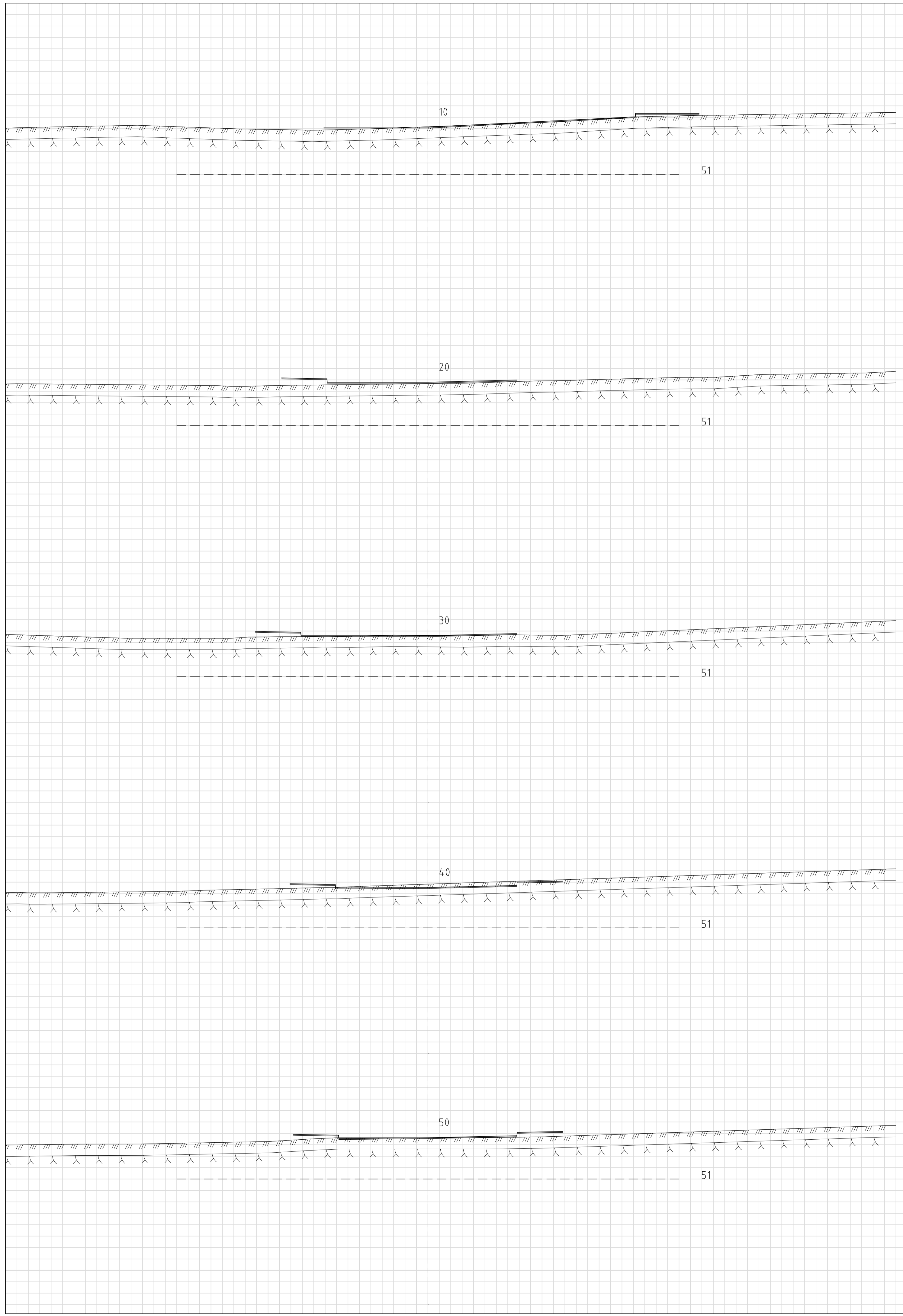

Rev. Revideringen gjelder	Dato	Tegnet	Kontroll	Godkj
Oppdragsgiver	Status			
Nedre Nøttveit Eiendom AS	Detaljregulering			
Prosjektnavn	Tegnet	Kontrollert	Godkjent	
Fana. Nedre Nøttveit boligfelt. Bergen - Gnr/Bnr. 88/84	VJ	THF	THF	
Nedre Nøttveit øst Tverrprofiler 10-90	Målestokk A1 1:100			
	Koordinatsystem EUREF89 UTM32 NN2000			
haugen <b>WVA</b>	Kanalveien 5 5068 Bergen Org. nr. 911 566 664 Tlf. +47 55 59 82 60 E-post: post@haugenvva.no Web: www.haugenvva.no	Prosjekt nr. 25015	Dato 10.09.2025	Rev.
		Tegning nr. U040	Fag Vei	